

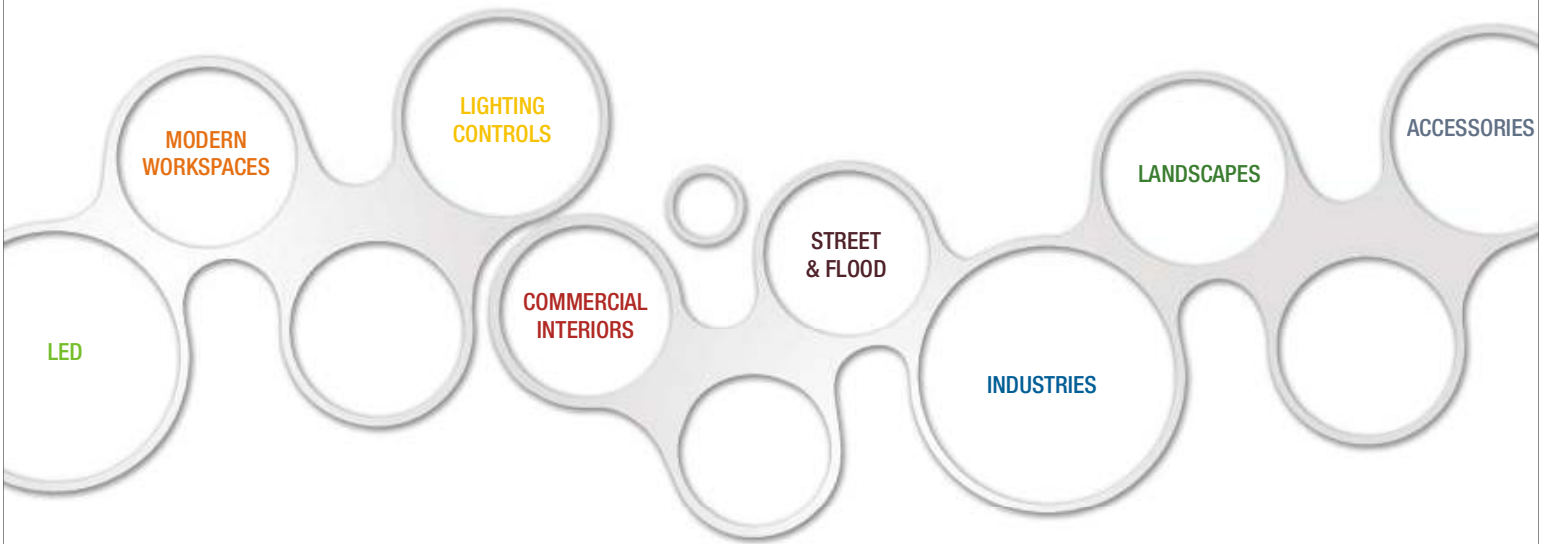

WIPRO
Applying Thought



WIPRO LIGHTING
Price List 2013

Effective September 1, 2013

Comprehensive solutions
for Indoor & Outdoor lighting

LED

Pg 01 – 24



**LIGHTING
CONTROLS**

Pg 39 – 40



**COMMERCIAL
INTERIORS**

Pg 41 – 50



**MODERN
WORKSPACES**

Pg 25 – 38



INDUSTRIES

Pg 51 – 62



LANDSCAPES

Pg 71 – 76

ACCESSORIES

Pg 77 – 78



**STREET
& FLOOD**

Pg 63 – 70



Discontinued Products | Pg 79 ▪ Terms & Conditions | Pg 80 ▪ Wipro Businesses | Pg 81 ▪ Branch Offices | Pg 83

LED an evolution



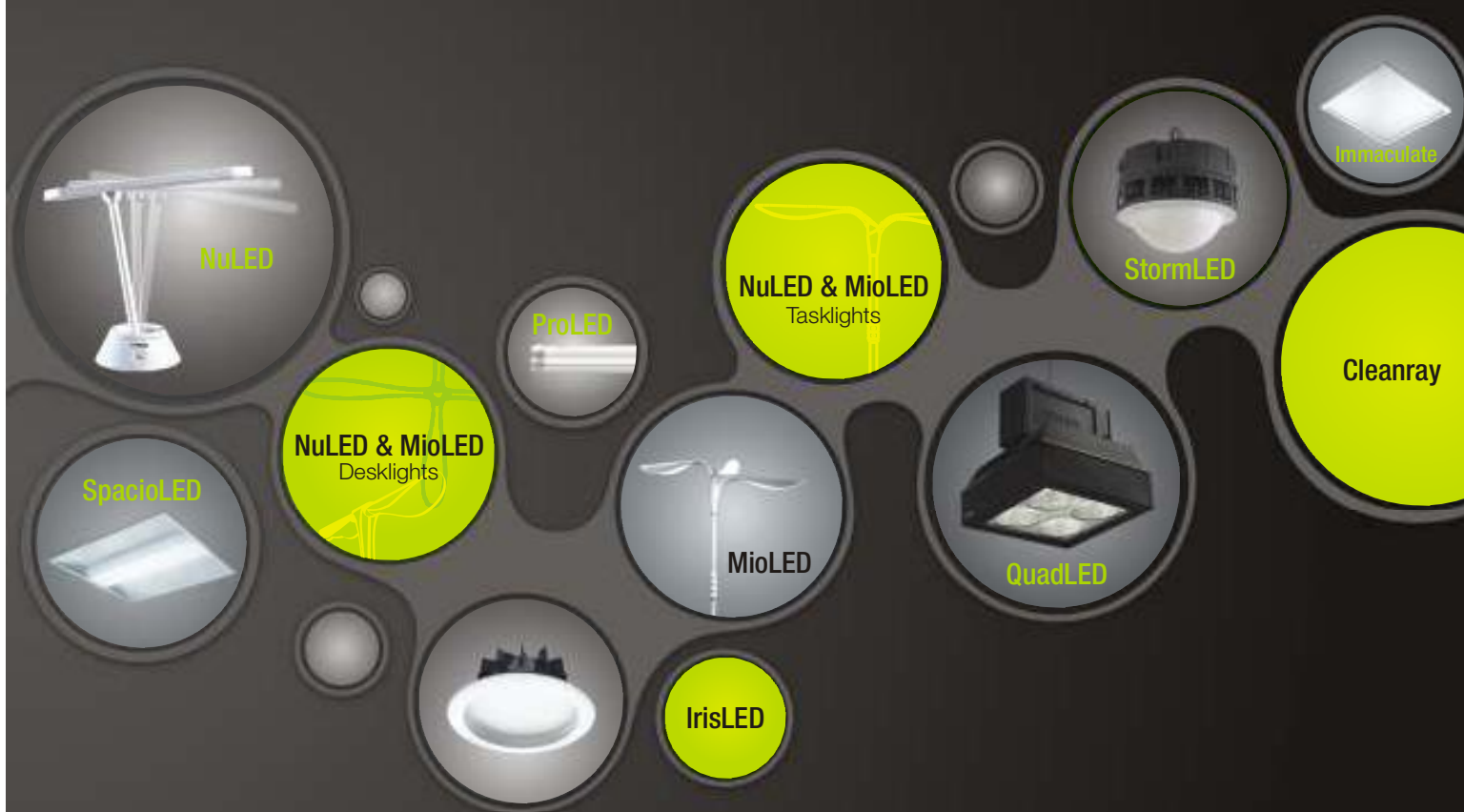

LED

reasons to adapt
for various applications

offices



excellent quality of light
with energy savings upto 50%

retail



attractive paybacks and
a service life of 50000 hrs



LED luminaires are available in different
colour temperatures on request

03





industries

outdoor



long lasting and
low operating cost



green lighting and
highly efficient design



LED



new

SpacioLED
LM 15

Recess mounted indirect-direct LED luminaire for new-age workspaces

DESIGN REGISTERED

LM15-321-XXX-60-XX	35 W	₹ 9000
LM15-411-XXX-60-XX	45 W	₹ 9900

Cutout dimensions: 595mm x 595mm

new

MatrixLED
LM 17

Recess mounted LED luminaire for new-age workspaces

DESIGN REGISTERED

LM17-291-XXX-57-XX	29 W	₹ 10300
LM17-411-XXX-57-XX	40 W	₹ 11250

Cutout dimensions: 595mm x 595mm

CresLED
LM 11

Recess mounted LED luminaire for new-age workspaces

DESIGN REGISTERED

LM11-291-XXX-57-XX	29 W	₹ 13500
LM11-411-XXX-57-XX	40 W	₹ 16500

Cutout dimensions: 572mm x 572mm

TZLED
LM 35

Recess mounted slim LED luminaire suitable for Techzone™ ceiling



new

LM35-361-XXX-57-XX	29 W	On request
--------------------	------	------------

Cutout dimensions: 1178mm x 133mm

LineosLED
LM 30

Recess mounted slim LED luminaire



new

LM30-211-XXX-57-XX	21 W	₹ 10500
--------------------	------	---------

Cutout dimensions: 1178mm x 78mm

GravityLED
LM 72

Linear suspended LED luminaire



new

LM72-521-XXX-60-XX	56 W	₹ 19700
--------------------	------	---------

Please order suspension system separately

DESIGN REGISTERED

OrbitLED
LM 71

Circular suspended fully diffused LED luminaire



new

LM71-531-XXX-60-XX	58 W	₹ 20000
--------------------	------	---------

Product is inclusive of suspension system

TubeLED
LM 70

Tubular suspended LED luminaire



new

LM70-421-XXX-57-XX	43 W	₹ 18100
--------------------	------	---------

Please order suspension system separately

DESIGN REGISTERED

Suspension for GravityLED, TubeLED

Universal suspension system with quick onsite adjustment: mounting with 2 nos. suspensions from ceiling



WVX501/LMX721	Suitable for installation on RCC ceiling	₹ 700
WVX502/LMX722	Suitable for installation on modular grid Armstrong Prelude 24 mm exposed suspension system	₹ 750
WVX503/LMX723	Suitable for installation on modular grid Armstrong, Silhouette 15 mm	₹ 750

Suspension Series : WVX50 is for TubeLED | LMX72 is for GravityLED



LED

light in an all new form



NuLED

LM 60

Furniture integrated LED tasklights



LM60-111-XXX-50-01	12 W	₹ 16900
LM60-211-XXX-50-02	25 W	₹ 26800
LM60-321-XXX-50-03	38 W	₹ 36850
LM60-431-XXX-50-04	51 W	₹ 47550

MioLED

LM 61

Furniture integrated LED tasklights



LM61-111-XXX-50-01	12 W	₹ 17400
LM61-211-XXX-50-02	25 W	₹ 27300
LM61-321-XXX-50-03	38 W	₹ 37350
LM61-431-XXX-50-04	51 W	₹ 48050

high energy savings, lower light power density

Lighting solution with ambient + task lighting ensures energy savings upto 50%, creates vibrant interiors and reduces the light power density (LPD), significantly

AMBIENT LIGHTING SOLUTION

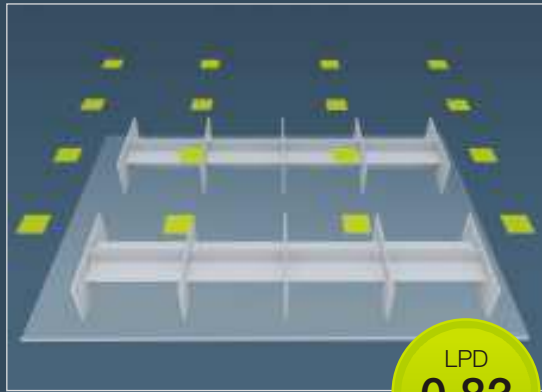

LPD
0.83
W/sq ft

No of workstations: 16 nos
Ambient Lighting Luminaires: 16 nos
LPD : 0.83 W/sq ft
Lux Levels on the work-surface: 300 lux avg.

AMBIENT + TASK LIGHTING SOLUTION

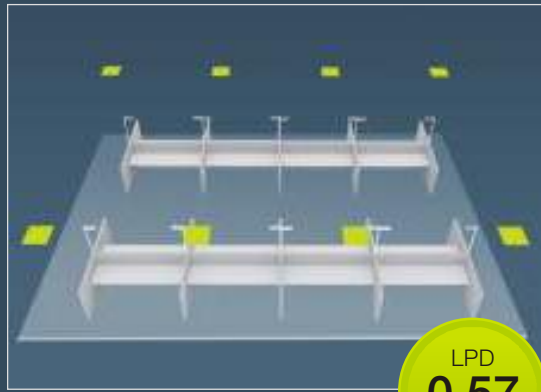

LPD
0.57
W/sq ft

No of workstations: 16 nos
Ambient Lighting Luminaires: 8 nos
LED Task Lighting : 16 nos
LPD : 0.57 W/sq ft
Lux Levels on the work-surface: 275 – 300 lux avg.

LED

wide range to suit a variety of workstation configurations



 Indic's first leg and beam based system

 WE
Wipro Ergonomic

Vibrant[™] plus

Suitable for installation on Wipro / Other* modular furniture systems
*Kindly contact our nearest branch office for more details

LED



bringing light closer to the task area

Too much light or too little, can lead to increased levels of fatigue in office. Optimizing energy usage without compromising on light levels and user well-being, becomes critical. Reducing ambient lighting and bringing light closer in the form of a tasklight makes a big difference – improving personal comfort, concentration and productivity.



NuLED desk

LM 62

Personal LED desklights



LM62-360-XXX-50-XX	4 W	₹ 8300
--------------------	-----	--------



MioLED desk

LM 63

Personal LED desklights



LM63-720-XXX-50-XX	8 W	₹ 9050
--------------------	-----	--------



mioLED
A MICHAEL FOLEY DESIGN

versatile & personal

Lighting for personal spaces needs to be adaptable to individual choices and preferences. Addressing personal controls to further precision, NuLED and MioLED desklight offers easy adjustments in tilt and angle. It eliminates shadows and is more useful especially when it is being used in very low ambient light conditions.



MyLED
LM 90

Workstation mounted LED personal tasklight with a 180 deg swivel



LM90-003-XXX-WH-XX	5 W	₹ 3150
LA 9004	clamp for 40mm partition	₹ 250
LA 9008	clamp for 50mm partition	₹ 300
LA 9006	clamp for 60mm partition	₹ 325



LED



irisLED

high energy savings

IrisLED delivers high efficiency and performance in every space it illuminates. It offers key user benefits – Energy savings of more than 50%, long life, green, free from mercury, IR and UV content.



IrisLED LD 71
High efficiency circular LED downlighter



DESIGN REGISTERED
(MRP)

LD71-101-XXX-50-XX (mini)*	11 W	₹ 2790
LD71-121-XXX-50-XX (iris)**	14 W	₹ 2890
LD71-151-XXX-50-XX (maxi)**	16 W	₹ 3190

Cutout dimensions: *Ø111mm | ** Ø142mm



IrisLED SQ LD 74
High efficiency square LED downlighter



DESIGN REGISTERED
(MRP)

LD74-101-XXX-50-XX (mini)*	11 W	₹ 2790
LD74-121-XXX-50-XX (iris sq)**	14 W	₹ 2890
LD74-151-XXX-50-XX (maxi)***	16 W	₹ 3190

Cutout dimensions:
*97mm x 97mm | **117mm x 117mm | ***137mm x 137mm



irisLED
performance for life

Specially designed wave shaped radial heat sink in IrisLED increases the overall surface area ensuring effective thermal management, reliable performance and long service life.



SiriLED

a LED upgrade for lifetime benefits

The retrofit solution provides attractive savings in the initial investment clubbed with the benefits of LED technology. The well structured and designed LED module enables hassle-free and quick installation retaining the existing POP ceilings.



SiriLED

LD 40

Retrofit LED downlighter



new

LD40-101-XXX-50-XX	11 W	On request
LD40-121-XXX-50-XX	14 W	On request
LD40-151-XXX-50-XX	16 W	On request

Retrofit suitable for downlighters with cut out dia of 168mm in standard height

LED

SpotzLED

LD 35/70

Recess circular LED downlighter with prismatic collimator lens



LD35-400-XXX-50-XX	6 W (White finish)	₹ 2800
LD70-400-XXX-50-XX	6 W (Textured chrome finish)	₹ 2800

Cutout dimensions: Ø53mm



LED



PlayLED LD 44/42

Recess mounted circular LED downlighter with special frosted diffuser



LD44-012-XXX-WH-XX	17 W	₹ 6300
LD42-024-XXX-WH-XX	33 W	₹ 10400

Cutout dimensions: Ø168mm

PlayLED LD 33

Recess mounted square LED downlighter with special frosted diffuser



LD33-024-XXX-WH-XX	33 W	₹ 9800
--------------------	------	--------

Cutout dimensions: 170mm x 170mm

PlayLED LD 51

Surface mounted circular LED downlighter for multi-utility applications



LD51-006-XXX-WH-XX	9 W	₹ 4900
LD51-012-XXX-WH-XX	17 W	₹ 10600

PlayLED LD 60/61

Recess mounted LED swivel downlighter for accent lighting



LD60-013-XXX-WH-XX	17 W	₹ 9400
LD61-026-XXX-WH-XX	33 W	₹ 17500

Cutout dimensions: 155mm x 155mm | 155mm x 298mm

AvioLED LD 64/65

LED projector light



LD64-013-XXX-WH-XX	17 W (white housing)	₹ 10650
LD65-013-XXX-WH-XX	17 W (black housing)	₹ 10650

TrimLED
LL 20
LED batten suitable for indoor application



new

		(MRP)
LL20-221-XXX-60-XX	24 W	₹ 2890

StormLED
LE 02
IP 65 high efficiency LED wellglass



new

LE02-351-XXX-65-XX	37 W	₹ 11850
--------------------	------	---------

WegaLED
LX 02
Surface mounted, multi-utility LED luminaire



DESIGN REGISTERED

LX02-013-160-WH-XX	17 W	₹ 11150
--------------------	------	---------

VisionLED
LC 20
Recess mounted, bottom opening cleanroom LED luminaire



DESIGN REGISTERED

LC20-411-XXX-50-XX	47 W	₹ 18900
--------------------	------	---------

Cutout dimensions: 487mm x 487mm



QuadLED
energy efficient & maintenance-free



QuadLED transforms the midbay in an aesthetic square profile adding an innovative design edge to the industry shop floors

QuadLED
LH 01/05
Suspended/surface mounted, multi-utility LED luminaire



new

LH01-751-XXX-50-XX (wide beam)	89 W	₹ 39250
LH01-102-XXX-50-XX (wide beam)	119 W	₹ 41300
LH05-751-XXX-50-XX (narrow beam)	89 W	₹ 40000
LH05-102-XXX-50-XX (narrow beam)	119 W	₹ 42050
LH05-172-XXX-50-XX (narrow beam)	174 W	₹ 53000

LED

XlineLED
LE 10
Industrial integral LED channel



new

LE10-491-XXX-57-XX	39 W	₹ 9000
--------------------	------	--------

ProLED
LL 06/12
High efficiency LED linear lamp



new

		(MRP)
LL06-800/65*	10 W	₹ 2090
LL12-161/65*	20 W	₹ 2790

*65 stands for 6500K

CoralLED
WIO 80
Indoor decorative channel housing suitable for ProLED



new

WIO80-1108	10 W	₹ 575
WIO80-1208	20 W	₹ 650

*Please order suitable ProLED separately

ProLED
Energy efficient LED Linear lamp

high efficiency solution for multiple application

ProLED linear lamp proves to be an efficient lighting solution in every aspect when compared with conventional FTL. This next generation lamp is a smart replacement for conventional (T8) fluorescent lamps.

WCO 12
WCO 12
Industrial channel housing suitable for ProLED



new

WCO12-121108	10 W	₹ 600
WCO12-122108	20 W	₹ 650
WCO12-121208	20 W	₹ 750
WCO12-122208	40 W	₹ 800

*Please order suitable ProLED separately

CapsuleLED
WIO 83
Industrial corrosion proof IP 65 housing suitable for ProLED



new

WIO83-1208	10 W	₹ 3000
WIO83-2208	20 W	₹ 3600

*Please order suitable ProLED separately

new



IndiRoadLED

LR 10

High performance LED streetlight suitable for primary/secondary roads



LR10-611-XXX-57-XX	60 W	₹ 27000
LR10-711-XXX-57-XX	71 W	₹ 29000
LR10-911-XXX-57-XX	91 W	₹ 33000
LR10-122-XXX-57-XX	121 W	₹ 39000
LR10-132-XXX-57-XX	132 W	₹ 42000

ScaiLED

LR 20

Designer LED streetlight with pressure die-cast housing suitable for primary roads



LR20-048-XXX-WH-XX	68 W	₹ 43000
LR20-072-XXX-WH-XX	102 W	₹ 52000
LR20-104-XXX-WH-XX	135 W	₹ 68000

LED

OrioLED

LR 01

Designer LED streetlight with pressure die-cast housing suitable for secondary roads



LR01-012-XXX-WH-XX	17 W	₹ 8600
LR01-018-XXX-WH-XX	25 W	₹ 10700
LR01-024-XXX-WH-XX	33 W	₹ 11900

CruzLED

LR 21

High performance LED streetlight suitable for primary/secondary roads



new

LR21-421-XXX-WH-XX	48 W	₹ 26550
LR21-631-XXX-WH-XX	73 W	₹ 34550
LR21-841-XXX-WH-XX	95 W	₹ 40050

LED



flexible LED striplight

FormzLED combines the efficiency of LEDs along with the flexibility of striplight. Its easy to install module perfectly blends along the curves creating a seamless lighting effect.

FormzLED

LS 06/26

IP 20 and IP 65 non-integral flexible LED strip light



LS06-005-120-WH-50	4.8 W per mtr, 5m spool; IP 20	₹ 4600
LS06-005-120-WW-50	4.8 W per mtr, 5m spool; IP 20	₹ 4600
LS06-005-120-BL-50	4.8 W per mtr, 5m spool; IP 20	₹ 4600
LS06-015-120-WH-50	14.4 W per mtr, 5m spool; IP 20	₹ 14450
LS06-015-120-WW-50	14.4 W per mtr, 5m spool; IP 20	₹ 14450
LS06-015-120-BL-50	14.4 W per mtr, 5m spool; IP 20	₹ 14450
LS26-005-120-WH-50	4.8 W per mtr, 5m spool; IP 65	₹ 7800
LS26-005-120-WW-50	4.8 W per mtr, 5m spool; IP 65	₹ 7800
LS26-005-120-BL-50	4.8 W per mtr, 5m spool; IP 65	₹ 7800
LS26-015-120-WH-50	14.4 W per mtr, 5m spool; IP 65	₹ 17950
LS26-015-120-WW-50	14.4 W per mtr, 5m spool; IP 65	₹ 17950
LS26-015-120-BL-50	14.4 W per mtr, 5m spool; IP 65	₹ 17500
LG40-024*	LED driver 240 V/12V	₹ 1575
LG40-078**	LED driver 240 V/12V	₹ 3650

*LG40-024 - 1 unit is suitable for 1 no (5m spool) of LS06/LS26-005

**LG40-078 - 1 unit is suitable for 1 no (5m spool) of LS26-015

*Order driver separately. Driver is for indoor use only.

MoonLED

LW 01

Circular LED wall light suitable for true ceiling



		(MRP)
LW01-101-XXX-60-XX	13 W	₹ 2400

MoonLED SQ

LW 02

Square LED wall light suitable for true ceiling



		(MRP)
LW02-101-XXX-60-XX	13 W	₹ 2400

LED Bollard

LB 10

IP 44 integral LED bollard
[0.3m and 0.8m height]



LB10-003-360-WH-03	3 W	230V	₹ 16100
LB10-003-360-WW-03	3 W	230V	₹ 16100
LB10-003-360-WH-08	3 W	230V	₹ 19200
LB10-003-360-WW-08	3 W	230V	₹ 19200

LED Steplight

LT 54

IP 65 integral LED steplight



LT54-002-XXX-RD-XX	2.2 W	230V	₹ 5650
LT54-002-XXX-GR-XX	2.2 W	230V	₹ 5650
LT54-002-XXX-BL-XX	2.2 W	230V	₹ 5650
LT54-002-XXX-AM-XX	2.2 W	230V	₹ 8600
LT54-002-XXX-WH-XX	2.2 W	230V	₹ 5650
LT54-002-XXX-WW-XX	2.2 W	230V	₹ 6000

LED Bushlight

LF 15

IP 67 integral LED bushlight



LF15-003-045-RD-XX	3 W	230V	₹ 13850
LF15-003-045-GR-XX	3 W	230V	₹ 13850
LF15-003-045-BL-XX	3 W	230V	₹ 13850
LF15-003-045-AM-XX	3 W	230V	₹ 14250
LF15-003-045-WH-XX	3 W	230V	₹ 13850
LF15-003-045-WW-XX	3 W	230V	₹ 14150
LF15-003-045-CC-XX*	3 W	12/24V	₹ 14250
LG70-004	RGB Controller	110-220V AC	₹ 66400

* Order RGB controller LG70-004 separately

LED Inground Light

LI 10

IP 67 non-integral LED inground light



LI10-003-045-RD-XX*	3 W	12V	₹ 10250
LI10-003-045-GR-XX*	3 W	12V	₹ 10250
LI10-003-045-BL-XX*	3 W	12V	₹ 10250
LI10-003-045-AM-XX*	3 W	12V	₹ 10650
LI10-003-045-WH-XX*	3 W	12V	₹ 10250
LI10-003-045-WW-XX*	3 W	12V	₹ 10600
LG12-010	LED Transformer	240V/12V	₹ 2400

* Order transformer LG12-010 separately

LED



low on consumption and
high on delivery



Immaculate
CRCO 10

Recess/surface mounted LED luminaire with complete diffuser



CRCO10R038HP57	38 W	₹ 15300
CRCO10S038HP57	38 W	₹ 16500

'R' represents recess and 'S' represents surface mounting

Cutout dimensions: 570mm x 570mm

Pinnacle
CRCO 11

Recess mounted LED luminaire with complete prismatic diffuser suitable for modular ceiling



CRCO11R038HP57	38 W	₹ 13500
----------------	------	---------

Cutout dimensions: 570mm x 570mm



Pinnacle Plus
CRCO 18

Recess mounted LED luminaire with prismatic diffuser suitable for modular ceiling



CRCO18R038HP57	38 W	₹ 10000
----------------	------	---------

Cutout dimensions: 570mm x 570mm





new

Aura Plus

CRCO 13

Recess/surface mounted LED luminaire



CRCO13R038HP57	38 W	₹ 14500
CRCO13S038HP57	38 W	₹ 19800

'R' represents recess and 'S' represents surface mounting

Cutout dimensions: 1180mm x 280mm

Aura

CRCO 12

Recess mounted LED luminaire



CRCO12R038HP57	38 W	₹ 12500
----------------	------	---------

Cutout dimensions: 1170mm x 270mm

Ranger

CRCO 14

Recess/surface mounted LED luminaire



CRCO14R024HP57	24 W	₹ 8500
CRCO14S024HP57	24 W	₹ 9800

'R' represents recess and 'S' represents surface mounting

Cutout dimensions: 570mm x 270mm



SlimrisLED
CRDL 14

Recess mounted circular slim LED luminaire



new

		(MRP)
CRDL14R005HP60*	6 W	₹ 1790
CRDL14R010HP60**	11 W	₹ 2290
CRDL14R015HP60***	17 W	₹ 2790

Cutout dimensions: * \varnothing 90mm | ** \varnothing 115mm | *** \varnothing 140mm

SquarisLED
CRDL 15

Recess mounted square slim LED luminaire



new

		(MRP)
CRDL15R005HP60*	6 W	₹ 1790
CRDL15R010HP60**	11 W	₹ 2290
CRDL15R015HP60***	17 W	₹ 2790

Cutout dimensions:
*90mm x 90mm | **115mm x 115mm | ***140mm x 140mm

SpherisLED
CRDL 10

Recess mounted circular LED downlighter



new

		(MRP)
CRDL10R005HP60*	6 W	₹ 2090
CRDL10R010HP60**	11 W	₹ 2390
CRDL10R015HP60***	17 W	₹ 2890

Cutout dimensions: * \varnothing 90mm | ** \varnothing 115mm | *** \varnothing 140mm



Halo
CRDL 11

Recess mounted circular LED downlighter



CRDL11R008HP57	8 W	₹ 3200
CRDL11R013HP57	13 W	₹ 3400
CRDL11R017HP57	17 W	₹ 4000
CRDL11R023HP57	23 W	₹ 4350

Cutout dimensions: \varnothing 172mm

Halo
CRDL 11

Recess mounted circular LED downlighter



CRDL11R033HP57	33 W	₹ 8200
----------------	------	--------

Cutout dimensions: \varnothing 220mm



Halo

CRDL 11

Surface mounted circular LED downlighter



CRDL11S008HP57	8 W	₹ 4150
CRDL11S013HP57	13 W	₹ 4450
CRDL11S017HP57	17 W	₹ 5100
CRDL11S023HP57	23 W	₹ 5400

Halo

CRDL 11

Surface mounted circular LED downlighter



CRDL11S033HP57	33 W	₹ 9800
----------------	------	--------

Spotify
CRDL 12/13
Recess mounted circular LED downlighter



CRDL12R007HP57	7 W (White finish)	₹ 2950
CRDL13R007HP57	7 W (Textured chrome finish)	₹ 2950

Cutout dimensions: Ø100mm



sleek and compact
LED downlighter

Efficiently highlight and accentuate merchandise using sleek and compact spotify with saving in operating costs.

Solitaire
CRCO 15
Recess mounted square LED downlighter



CRCO15R013HP57	13 W	₹ 4300
----------------	------	--------

Cutout dimensions: 160mm x 160mm

Stunner
CRCO 17
Recess/surface mounted LED luminaire



CRCO17R013HP57	13 W	₹ 4750
CRCO17S013HP57	13 W	₹ 5750

'R' represents recess and 'S' represents surface mounting

Cutout dimensions: 310mm x 310mm

CleanLED
CRDO 10
LED batten suitable for indoor application



CRDO10W024HP57	24 W	(MRP) ₹ 2790
----------------	------	-----------------

LED



Modern Workspaces



enhancing
productivity
through
quality of light



Good quality lighting
adds life to the workspace
enhancing its ambience and
creating a healthy, cheerful
work environment



Sonic
WVP 59/WVF 59

Recess mounted indirect-direct luminaire suitable for CFL (TC-L) lamps

APPLIED FOR DESIGN REGISTRATION

WVP 59236	2 x 36 W CFL (TC-L)	₹ 5650
WVP 59236 SGW	2 x 36 W CFL (TC-L)	₹ 6150

Recess mounted indirect-direct luminaire suitable for FTL (T5) lamps

WVF 59314 SGW	3 x 14 W FTL (T5)	₹ 6500
WVF 59414 SGW	4 x 14 W FTL (T5)	₹ 6700

Cutout dimensions: 575mm x 575mm

Spacio
WVP 52/WVF 53

Recess mounted indirect-direct luminaire with High Efficiency Translucence [HET] technology, suitable for CFL (TC-L) lamps

APPLIED FOR DESIGN REGISTRATION

WVP 52236	2 x 36 W CFL (TC-L)	₹ 4950
WVP 52236 SG	2 x 36 W CFL (TC-L)	₹ 5050
WVP 52236 SGW	2 x 36 W CFL (TC-L)	₹ 5450
WVP 52140 SGW	1 x 40 W CFL (TC-L)	₹ 5250
WVP 52155 SGA	1 x 55 W CFL (TC-L)	₹ 6050

Recess mounted indirect-direct luminaire with High Efficiency Translucence [HET] technology, suitable for FTL (T5) lamps

WVF 53224 SGA	2 x 24 W FTL (T5)	₹ 6000
WVF 53314 SGW	3 x 14 W FTL (T5)	₹ 5800
WVF 53414 SGW	4 x 14 W FTL (T5)	₹ 6000

Cutout dimensions: 565mm x 565mm

Synergy
WVF 16

Recess mounted direct-indirect luminaire suitable for FTL (T5) lamps

APPLIED FOR DESIGN REGISTRATION

WVF 16414 SGW	4 x 14 W FTL (T5)	On request
---------------	-------------------	------------

Cutout dimensions: 573mm x 573mm

Dune
WVF 15

Recess mounted direct-indirect luminaire suitable for FTL (T5) lamps

APPLIED FOR DESIGN REGISTRATION

WVF 15414 SGW	4 x 14 W FTL (T5)	On request
---------------	-------------------	------------

Cutout dimensions: 573mm x 573mm

modern workspaces

Modern Workspaces

Ideos

WVP 78/WVF 78

Recess mounted direct-indirect luminaire with double parabolic louvres and acrylic diffuser, suitable for CFL (TC-L) lamps



WVP 78236	2 x 36 W CFL (TC-L)	₹ 4700
WVP 78236 SG	2 x 36 W CFL (TC-L)	₹ 4800
WVP 78236 SGW	2 x 36 W CFL (TC-L)	₹ 5200
WVP 78240 SGA	2 x 40 W CFL (TC-L)	₹ 5750
WVP 78255 SGA	2 x 55 W CFL (TC-L)	₹ 5950

Recess mounted direct-indirect luminaire with double parabolic louvres and acrylic diffuser, suitable for FTL (T5) lamps

WVF 78414 SGW	4 x 14 W FTL (T5)	₹ 6200
---------------	-------------------	--------

Cutout dimensions: 565mm x 565mm

Ideos

WVP 79/WVF 79

Recess mounted direct-indirect luminaire with paralite P5 louvres and acrylic diffuser, suitable for CFL (TC-L) lamps



WVP 79236 SG	2 x 36 W CFL (TC-L)	₹ 4900
WVP 79236 SGW	2 x 36 W CFL (TC-L)	₹ 5300
WVP 79240 SGA	2 x 40 W CFL (TC-L)	₹ 5850
WVP 79255 SGA	2 x 55 W CFL (TC-L)	₹ 6050

Recess mounted direct-indirect luminaire with paralite P5 louvres and acrylic diffuser, suitable for FTL (T5) lamps

WVF 79414 SGW	4 x 14 W FTL (T5)	₹ 6250
---------------	-------------------	--------

Cutout dimensions: 565mm x 565mm



Platina

WVP 76/WVF 76

Recess mounted direct-indirect luminaire with translucent acrylic diffuser, suitable for CFL (TC-L) lamps



WVP 76236	2 x 36 W CFL (TC-L)	₹ 3650
WVP 76236 SG	2 x 36 W CFL (TC-L)	₹ 3750
WVP 76236 SGW	2 x 36 W CFL (TC-L)	₹ 4100
WVP 76240 SGA	2 x 40 W CFL (TC-L)	₹ 4700
WVP 76255 SGA	2 x 55 W CFL (TC-L)	₹ 4900

Recess mounted direct-indirect luminaire with translucent acrylic diffuser, suitable for FTL (T5) lamps

WVF 76414 SGW	4 x 14 W FTL (T5)	₹ 5200
---------------	-------------------	--------

Cutout dimensions: 565mm x 565mm

Softlite

WCP 63/WCF 63



Recess mounted indirect-direct luminaire with square perforations, suitable for CFL (TC-L) lamps

WCP 63236	2 x 36 W CFL (TC-L)	₹ 3550
WCP 63236 SG	2 x 36 W CFL (TC-L)	₹ 3650
WCP 63236 SGW	2 x 36 W CFL (TC-L)	₹ 4050
WCP 63240 SGA	2 x 40 W CFL (TC-L)	₹ 4600
WCP 63255 SGA	2 x 55 W CFL (TC-L)	₹ 4800

Recess mounted indirect-direct luminaire with square perforations, suitable for FTL (T5) lamp

WCF 63414 SGW	4 x 14 W FTL (T5)	₹ 4950
---------------	-------------------	--------

Cutout dimensions: 565mm x 565mm

Fusion

WCP 64/WCF 64



Recess mounted direct-indirect luminaire with paralite P5 louvres, suitable for CFL (TC-L) lamps

WCP 64236	2 x 36 W CFL (TC-L)	₹ 3900
WCP 64236 SG	2 x 36 W CFL (TC-L)	₹ 4100
WCP 64236 SGW	2 x 36 W CFL (TC-L)	₹ 4350
WCP 64240 SGA	2 x 40 W CFL (TC-L)	₹ 4950
WCP 64255 SGA	2 x 55 W CFL (TC-L)	₹ 5150

Recess mounted direct-indirect luminaire with paralite P5 louvres, suitable for FTL (T5)

WCF 64414 SGW	4 x 14 W FTL (T5)	₹ 5300
---------------	-------------------	--------

Cutout dimensions: 565mm x 565mm

Pristine

WVP 56



The next generation recess mounted indirect-direct luminaire with square perforations, suitable for CFL (TC-L) lamps

WVP 56236	2 x 36 W CFL (TC-L)	₹ 3750
WVP 56236 SG	2 x 36 W CFL (TC-L)	₹ 3850
WVP 56236 SGW	2 x 36 W CFL (TC-L)	₹ 4250
WVP 56240 SGA	2 x 40 W CFL (TC-L)	₹ 4800
WVP 56255 SGA	2 x 55 W CFL (TC-L)	₹ 5000

Cutout dimensions: 574mm x 574mm

Etern

WVP 57



The next generation recess mounted direct-indirect luminaire with paralite P5 louvres, suitable for CFL (TC-L) lamps

WVP 57236 SG	2 x 36 W CFL (TC-L)	₹ 4200
WVP 57236 SGW	2 x 36 W CFL (TC-L)	₹ 4600
WVP 57240 SGA	2 x 40 W CFL (TC-L)	₹ 5100
WVP 57255 SGA	2 x 55 W CFL (TC-L)	₹ 5300

Cutout dimensions: 574mm x 574mm

modern workspaces

Modern Workspaces

GCF 39

GCF 39

Recess mounted linear luminaire suitable for Techzone™ ceiling



new

GCF 39128 SGW	1 x 28 W FTL (T5)	On request
GCF 39228 SGW	2 x 28 W FTL (T5)	On request

GCF 45

GCF 45

Recess mounted linear luminaire suitable for Techzone™ ceiling



new

GCF 45128 SGW	1 x 28 W FTL (T5)	On request
GCF 45228 SGW	2 x 28 W FTL (T5)	On request

WVF 23

WVF 23

Recess mounted mirror optics luminaire suitable for Techzone™ ceiling



new

WVF 23128 SGW	1 x 28 W FTL (T5)	On request
WVF 23228 SGW	2 x 28 W FTL (T5)	On request

Lineos

GCF 31

Recess mounted linear contour light suitable for FTL (T5) lamps



GCF 31128 SGW	1 x 28 W FTL (T5)	length – 1195 mm	₹ 5100
GCF 31228 SGW	2 x 28 W FTL (T5)	length – 2290 mm	₹ 10250
GCF 31154 SGA	1 x 54 W FTL (T5)	length – 1195 mm	₹ 5900
GCF 31254 SGA	2 x 54 W FTL (T5)	length – 2290 mm	₹ 11800

Recess mounted linear contour light suitable for FTL (T5) lamps for continuous band of light

GCF 31128 SGW CT	1 x 28 W FTL (T5)	length – 1105 mm	₹ 5200
GCF 31228 SGW CT	2 x 28 W FTL (T5)	length – 2205 mm	₹ 10450
GCF 31154 SGA CT	1 x 54 W FTL (T5)	length – 1105 mm	₹ 6000
GCF 31254 SGA CT	2 x 54 W FTL (T5)	length – 2205 mm	₹ 12000

Cutout dimensions: 1178mm x 78mm (GCF 31128 SGW/ 31154 SGA)
2273mm x 78mm (GCF 31128 SGW/ 31254 SGA)
1096mm x 78 mm (GCF 31128 SGW CT/ 31154 SGA CT)
2191mm X 78 mm (GCF 31228 SGW CT/ 31254 SGA CT)

Lineos

GCF 32

Surface/ suspension mounted linear contour light suitable for FTL (T5) lamps

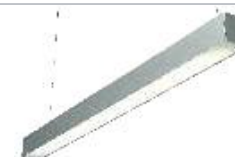

GCF 32128 SGW	1 x 28 W FTL (T5)	length – 1180 mm	₹ 6400
GCF 32228 SGW	2 x 28 W FTL (T5)	length – 2275 mm	₹ 11700
GCF 32154 SGA	1 x 54 W FTL (T5)	length – 1180 mm	₹ 7100
GCF 32254 SGA	2 x 54 W FTL (T5)	length – 2275 mm	₹ 13300

Surface/ suspension mounted linear contour light with FTL (T5) lamps for continuous band of light

GCF 32128 SGW CT	1 x 28 W FTL (T5)	length – 1098 mm	₹ 6500
GCF 32228 SGW CT	2 x 28 W FTL (T5)	length – 2193 mm	₹ 11900
GCF 32154 SGA CT	1 x 54 W FTL (T5)	length – 1098 mm	₹ 7300
GCF 32254 SGA CT	2 x 54 W FTL (T5)	length – 2193 mm	₹ 13500

Please order suspension system separately

Suspension – Lineos

WVX 86

A set of 2 point 'QUICK' install suspension system for Lineos



WVX 861	Suitable for RCC ceiling	₹ 675
WVX 862	Suitable for Armstrong Prelude 24 mm ceiling	₹ 675
WVX 863	Suitable for Armstrong Silhouette 15 mm ceiling	₹ 675

Special transparent power cable for Lineos

WVX 825	3 core transparent cable	₹ 150
WVX 826	2 core transparent cable	₹ 125



Float

WVF 82

Pendant mounted indirect luminaire; suitable for FTL (T5/T8) lamps



WVF 82236 SGW	2 x 36 W FTL (T8)	length – 1269 mm	₹ 6850
WVF 82228 SGW	2 x 28 W FTL (T5)	length – 1204 mm	₹ 6950
WVF 82254 SGA	2 x 54 W FTL (T5)	length – 1204 mm	₹ 8200
WVF 82436 SGW	4 x 36 W FTL (T8)	length – 2510 mm	₹ 14300
WVF 82428 SGW	4 x 28 W FTL (T5)	length – 2395 mm	₹ 14400
WVF 82454 SGA	4 x 54 W FTL (T5)	length – 2395 mm	₹ 16700

Prices include connecting bracket.
Please order suspension system separately

Suspension – Float

WVX 82

A set of 2 point 'QUICK' install suspension system for Float



WVX 821	Suitable for RCC ceiling	₹ 750
WVX 822	Suitable for Armstrong Prelude 24 mm ceiling	₹ 800
WVX 823	Suitable for Armstrong Silhouette 15 mm ceiling	₹ 800

Special transparent power cable for Float

WVX 825	3 core transparent cable	₹ 150
WVX 826	2 core transparent cable	₹ 125

Modern Workspaces



LIVET5
a range of suspended luminaires
suitable for T5 lamps

flexible lighting solution that
blends with your furniture layout

A complete family of energy efficient luminaires that assemble together to form the desired angles, perfectly aligning to the furniture layouts. The flexibility to design with light, the superior finish of the luminaires and its ability to create a live and welcoming space; ensures LiveT5 its design edge.



Live T5
WVF 34

Pendant mounted direct-indirect luminaire, suitable for FTL (T5) lamps

APPLIED FOR DESIGN PROJECTS

WVF 34228 SGW	2 x 28 W FTL (T5)	₹ 7200
WVF 34254 SGA	2 x 54 W FTL (T5)	₹ 8450

Please order suspension system and connector separately

Suspension – LiveT5
WVX 34

Universal suspension system with quick onsite adjustment and connector

WVX 341	Suitable for installation on RCC ceiling	₹ 800
WVX 342	Suitable for installation on modular grid Armstrong prelude ceiling	₹ 800
WVX 343	Suitable for installation on modular grid Armstrong silhouette ceiling	₹ 800
WVX 345	Connector suitable for installation of LiveT5 90°	₹ 950
WVX 344	Connector suitable for installation of LiveT5 120°	₹ 1050

Aeros – DP
WVF 83

pendant mounted indirect-direct luminaire with double parabolic louvres, suitable for FTL (T5) lamps

WVF 83228 SGW	2 x 28 W FTL (T5)	length – 1260 mm	₹ 7200
WVF 83254 SGA	2 x 54 W FTL (T5)	length – 1260 mm	₹ 8450
WVF 83428 SGW	4 x 28 W FTL (T5)	length – 2450 mm	₹ 15250
WVF 83454 SGA	4 x 54 W FTL (T5)	length – 2450 mm	₹ 17550

Please order suspension system and power cable separately

Aeros – MPL
WVF 84

Pendant mounted indirect-direct luminaire with micro prismatic diffuser, suitable for FTL (T5) lamps

WVF 84228 SGW	2 x 28 W FTL (T5)	length – 1260 mm	₹ 8400
WVF 84254 SGA	2 x 54 W FTL (T5)	length – 1260 mm	₹ 9350
WVF 84428 SGW	4 x 28 W FTL (T5)	length – 2450 mm	₹ 16800
WVF 84454 SGA	4 x 54 W FTL (T5)	length – 2450 mm	₹ 19550

Please order suspension system and power cable separately

Suspension – Aeros
WVX 83

A set of 2 point 'QUICK' install suspension system for Aeros - MPL and DP

WVX 831	Suitable for RCC ceiling	₹ 750
WVX 832	Suitable for Armstrong Prelude 24 mm ceiling	₹ 800
WVX 833	Suitable for Armstrong Silhouette 15 mm ceiling	₹ 800
Special transparent power cable for Aeros-DP and Aeros-MPL		
WVX 825	3 core transparent cable	₹ 150
WVX 826	2 core transparent cable	₹ 125



modern workspaces

Modern Workspaces



Direct T5
WVF 14

Recess mounted direct luminaire suitable for FTL (T5) lamps



APPLIED FOR DESIGN PROTECTION

WVF 14314 SGW	3 x 14 W FTL (T5)	₹ 6150
WVF 14414 SGW	4 x 14 W FTL (T5)	₹ 6500

Cutout dimensions: 572mm x 572mm

NT5
WVF 22

Next generation recess mounted luminaire, suitable for FTL (T5) lamps



WVF 22414 SGW	4 x 14 W FTL (T5)	₹ 6300
---------------	-------------------	--------

Cutout dimensions: 572mm x 572mm

NT5
WVF 22

Next generation recess mounted luminaire, suitable for FTL (T5) lamps



WVF 22228 SGW	2 x 28 W FTL (T5)	₹ 5550
---------------	-------------------	--------

Cutout dimensions: 274mm x 1172mm

Stellar
WVF 20

Recess mounted special geometric mirror optic luminaire suitable for FTL (T8) lamps



WVF 20418	4 x 18 W FTL (T8)	₹ 4600
WVF 20418 SGW	4 x 18 W FTL (T8)	₹ 6000

Cutout dimensions: 571mm x 571mm

Stellar
WVF 20

Recess mounted special geometric mirror optic luminaire suitable for FTL (T5) lamps



WVF 20314 SGW	3 x 14 W FTL (T5)	₹ 5550
---------------	-------------------	--------

Cutout dimensions: 571mm x 571mm

Stellar

WVF 20

Recess mounted special geometric mirror optic luminaire suitable for FTL (T5) lamp



WVF 20414 SGW	4 x 14 W FTL (T5)	₹ 5900
---------------	-------------------	--------

Cutout dimensions: 571mm x 571mm

Stellar

WVF 20

Recess mounted special geometric mirror optic luminaire suitable for FTL (T5) lamps



WVF 20228 SGW	2 x 28 W FTL (T5)	₹ 5400
---------------	-------------------	--------

Cutout dimensions: 1172mm x 271mm

Crescent

WVP 24

Recess mounted mirror optic luminaire with paralite P5 louvres, suitable for CFL (TC-L) lamps



WVP 24236 SG	2 x 36 W CFL (TC-L)	₹ 4850
WVP 24236 SGW	2 x 36 W CFL (TC-L)	₹ 5250
WVP 24336 SG	3 x 36 W CFL (TC-L)	₹ 6150
WVP 24336 SGW	3 x 36 W CFL (TC-L)	₹ 6750

Cutout dimensions: 573mm x 573mm

Crescent

WVP 25

Recess mounted mirror optic luminaire with paralite P5 louvres, suitable for CFL (TC-L) lamps



WVP 25136 SGW	1 x 36 W CFL (TC-L)	₹ 3400
WVP 25236 SG	2 x 36 W CFL (TC-L)	₹ 3500
WVP 25236 SGW	2 x 36 W CFL (TC-L)	₹ 3850

Cutout dimensions: 483mm x 274mm

Crescent

WVP 44

Surface mounted mirror optic luminaire with paralite P5 louvres, suitable for CFL (TC-L) lamp



WVP 44236 SG	2 x 36 W CFL (TC-L)	₹ 5200
WVP 44236 SGW	2 x 36 W CFL (TC-L)	₹ 5550

Crescent

WVP 45

Surface mounted mirror optic luminaire with paralite P5 louvres, suitable for CFL (TC-L) lamps



WVP 45136 SG	1 x 36 W CFL (TC-L)	₹ 3300
WVP 45136 SGW	1 x 36 W CFL (TC-L)	₹ 3650

Modern Workspaces



Matrix Plus

WVP 28

Recess mounted luminaire with paralite P5 louvres; suitable for CFL (TC-L) lamp



WVP 28236 SG	2 x 36 W CFL (TC-L)	₹ 4200
WVP 28236 SGW	2 x 36 W CFL (TC-L)	₹ 4550

Cutout dimensions: 565mm x 565mm

WCP 17 series

WCP 17

Recess mounted mirror optic luminaire with paralite P5 louvres; suitable for CFL (TC-L) lamps



WCP 17236 SG	2 x 36 W CFL (TC-L)	₹ 4650
WCP 17236 SGW	2 x 36 W CFL (TC-L)	₹ 5050
WCP 17336 SG	3 x 36 W CFL (TC-L)	₹ 5950
WCP 17336 SGW	3 x 36 W CFL (TC-L)	₹ 6550

Cutout dimensions: 573mm x 573mm

WCP 17 series

WCP 17

Recess mounted mirror optic luminaire with paralite P5 louvres; suitable for CFL (TC-L) lamps



WCP 17236 SGR	2 x 36 W CFL (TC-L)	₹ 3550
---------------	---------------------	--------

Cutout dimensions: 573mm x 208mm

Matrix

WCF 93/WCP 93

Recess mounted mirror optic luminaire with matt finish ribbed aluminium louvres, suitable for FTL (T8) & CFL (TC-L) lamps



WCF 93418	4 x 18 W FTL (T8)	₹ 3750
WCF 93418 SGW	4 x 18 W FTL (T8)	₹ 4500
WCP 93336	3 x 36 W CFL (TC-L)	₹ 4200
WCP 93336 SGW	3 x 36 W CFL (TC-L)	₹ 5100

Cutout dimensions: 571mm x 571mm

Matrix

WCF 93

Recess mounted mirror optic luminaire with matt finish ribbed aluminium louvres, suitable for FTL (T8) lamps



WCF 93236	2 x 36 W FTL (T8)	₹ 3750
WCF 93236 SGW	2 x 36 W FTL (T8)	₹ 4200

Cutout dimensions: 1224mm x 271mm

Matrix

WCF 97

Recess mounted mirror optic luminaire with double parabolic louvres, suitable for FTL (T8) lamps



WCF 97418	4 x 18 W FTL (T8)	₹ 4050
WCF 97418 SGW	4 x 18 W FTL (T8)	₹ 4800

Cutout dimensions: 571mm x 571mm

Matrix

WCF 97

Recess mounted mirror optic luminaire with double parabolic louvres, suitable for FTL (T8) lamps



WCF 97236	2 x 36 W FTL (T8)	₹ 3900
WCF 97236 SGW	2 x 36 W FTL (T8)	₹ 4350

Cutout dimensions: 1224mm x 271mm

Crest

WVF 58

Recess/surface mounted luminaire with unique dual finish louvre system, suitable for FTL (T5) lamps



WVF 58128 SG*	1 x 28 W FTL (T5)	₹ 2750
WVF 58128 SGW*	1 x 28 W FTL (T5)	₹ 3050
WVF 58228 SG**	2 x 28 W FTL (T5)	₹ 3200
WVF 58228 SGW**	2 x 28 W FTL (T5)	₹ 3450

Cutout dimensions: *1181mm x 82mm | **1181mm x 148mm

Crest

WVF 58

Recess/surface mounted luminaire with unique dual finish louvre system, suitable for FTL (T8) lamps



WVF 58136*	1 x 36 W FTL (T8)	₹ 2400
WVF 58136 SGW*	1 x 36 W FTL (T8)	₹ 2900
WVF 58236 **	2 x 36 W FTL (T8)	₹ 3000
WVF 58236 SGW**	2 x 36 W FTL (T8)	₹ 3450

Cutout dimensions: *1236mm x 82 mm | **1236mm x 177mm

Crest

WVF 48

Surface mounted luminaire with unique dual finish louvre system, suitable for FTL (T5) lamps



WVF 48228 SG	2 x 28 W FTL (T5)	₹ 3400
WVF 48228 SGW	2 x 28 W FTL (T5)	₹ 3650

Trail

WVF 49

Surface mounted luminaire suitable for FTL (T5) Lamps



WVF 49228 SG	2 x 28 W FTL (T5)	₹ 2650
WVF 49228 SGW	2 x 28 W FTL (T5)	₹ 2900

WCF 81 series

WCF 81

Surface/recess mounted mirror optic luminaire with matt finish ribbed aluminium louvres, suitable for FTL (T8) lamps



WCF 81236	2 x 36 W FTL (T8)	₹ 2850
WCF 81236 SG	2 x 36 W FTL (T8)	₹ 2950
WCF 81236 SGW	2 x 36 W FTL (T8)	₹ 3300

Cutout dimensions: 1224mm x 195mm

Modern Workspaces

WVF 40 series

WVF 40

Surface mounted mirror optic luminaire with X-mas matt finish louvres suitable for FTL (T8) lamps



WVF 40136	1 x 36 W FTL (T8)	₹ 2800
WVF 40136 SG	1 x 36 W FTL (T8)	₹ 2900
WVF 40136 SGW	1 x 36 W FTL (T8)	₹ 3250
WVF 40236	2 x 36 W FTL (T8)	₹ 3250
WVF 40236 SG	2 x 36 W FTL (T8)	₹ 3350
WVF 40236 SGW	2 x 36 W FTL (T8)	₹ 3700

WVF 41 series

WVF 41

Surface mounted mirror optic luminaire with double parabolic louvres suitable for FTL (T8) lamps



WVF 41136	1 x 36 W FTL (T8)	₹ 2900
WVF 41136 SG	1 x 36 W FTL (T8)	₹ 3000
WVF 41136 SGW	1 x 36 W FTL (T8)	₹ 3350
WVF 41236	2 x 36 W FTL (T8)	₹ 3400
WVF 41236 SG	2 x 36 W FTL (T8)	₹ 3500
WVF 41236 SGW	2 x 36 W FTL (T8)	₹ 3850

WCF 50 series

WCF 50

Decorative luminaire with clear acrylic cover suitable for FTL (T8) lamps



WCF 50140	1 x 40 W FTL (T8)	₹ 2000
WCF 50140 SG	1 x 40 W FTL (T8)	₹ 2100
WCF 50140 SGW	1 x 40 W FTL (T8)	₹ 2500
WCF 50240	2 x 40 W FTL (T8)	₹ 2750
WCF 50240 SG	2 x 40 W FTL (T8)	₹ 2850
WCF 50240 SGW	2 x 40 W FTL (T8)	₹ 3200

WCF 51 series

WCF 51

Decorative luminaire with opal acrylic cover suitable for FTL (T8) lamps



WCF 51140	1 x 40 W FTL (T8)	₹ 2000
WCF 51140 SG	1 x 40 W FTL (T8)	₹ 2100
WCF 51140 SGW	1 x 40 W FTL (T8)	₹ 2500
WCF 51240	2 x 40 W FTL (T8)	₹ 2750
WCF 51240 SG	2 x 40 W FTL (T8)	₹ 2850
WCF 51240 SGW	2 x 40 W FTL (T8)	₹ 3350

Comfort

WVF 90

Wall mounted personal bedlight



WVF 90118	1 x 18 W FTL (T8)	₹ 4600
	1 x 36 W CFL (TC-L)	
	1 x 10 W Coated GLS	

Comfort

WVF 95

Wall mounted personal bedlight with wired remote



WVF 95118	1 x 18 W FTL (T8)	₹ 4850
	1 x 36 W CFL (TC-L)	
	1 x 10 W Coated GLS	



modern workspaces

Sunshine
WVF 93

Wall mounted personal bedlight with 4 lighting modes; suitable for FTL (T5) lamps



WVF 93214 SGW	2 x 14 W FTL (T5)	₹ 7000
WVF 93228 SGW	2 x 28 W FTL (T5)	₹ 8700

Sunshine
WVF 94

Wall mounted personal bedlight with 4 lighting modes and wired remote; suitable for FTL (T5) lamps



WVF 94214 SGW	2 x 14 W FTL (T5)	₹ 7450
WVF 94228 SGW	2 x 28 W FTL (T5)	₹ 9000

Lighting Controls

Smart controls for smarter minds

Intelligent controls for cost, convenience & better comfort



eSense
COP 10/11

High performance, non regulating PIR occupancy sensors



COP 10006	Occupancy sensor	₹ 7200
COP 11010	Programmable occupancy sensor	₹ 8700

Cutout dimensions: Ø60 mm

eSense
CDA 13

High performance programmable PIR occupancy sensor with daylight dimming



CDA 13010	Occupancy sensor with daylight dimming suitable for 1-10V analogue ballast	₹ 12400
-----------	--	---------

Cutout dimensions: Ø60 mm

eSense
COM 20/CDA 21

High performance microwave occupancy and daylight dimming sensors



COM 20010	Occupancy sensor	₹ 20500
CDA 21010	Occupancy sensor with daylight dimming suitable for 1-10V analogue ballast	₹ 23750

Cutout dimensions: Ø60 mm

eSense
COM 23/CDA 24

High performance microwave occupancy and daylight dimming sensors



COM 23010	Occupancy sensor	₹ 17100
CDA 24010	Occupancy sensor with daylight dimming suitable for 1-10V analogue ballast	₹ 19150

Cutout dimensions: Ø60 mm

eSense
CSC 22/CDX 22
CIC 01/CCX 01



CSC 2202 + CDX 2202	2 GLS/Halogen (Magnetic), 2 fluorescent dimming (1-10 V), 2 switching circuits*	₹ 145800
CIC 01	Infra red remote control	₹ 11500
CCX 01	1-10 V dimming converter	₹ 14000

*In built dimming module

eSense
CIX 01

IR remote control



CIX 01	IR remote control	₹ 12200
--------	-------------------	---------

lighting controls

Commercial Interiors



Good lighting for commercial interiors is all about creating a good visual experience and adding vibrancy to the exhibits



inviting interiors full of dynamism & vibrancy





Dot
GCP 23

Recess mounted downlighter with satin finish reflector suitable for CFL lamps



GCP 23118	1 x 18 W CFL (TC-D)	₹ 1100
GCP 23118 SG	1 x 18 W CFL (TC-DE)	₹ 1250
GCP 23118 SGFG	1 x 18 W CFL (TC-DE)	₹ 1550
GCP 23218	2 x 18 W CFL (TC-D)	₹ 1350
GCP 23218 SG	2 x 18 W CFL (TC-DE)	₹ 1700
GCP 23218 SGFG	2 x 18 W CFL (TC-DE)	₹ 2000

Cutout dimensions: ø160mm

commercial interiors

Cubix 15
GCP 15

Recess mounted low depth square downlighter with satin finish reflector and frosted diffuser suitable for CFL lamps



GCP 15113	1 x 13 W CFL (TC-D)	₹ 1750
GCP 15118	1 x 18 W CFL (TC-D)	₹ 1750
GCP 15213	2 x 13 W CFL (TC-D)	₹ 2000
GCP 15218	2 x 18 W CFL (TC-D)	₹ 2000
GCP 15118 SG	1 x 18 W CFL (TC-DE)	₹ 1900
GCP 15118 SGW	1 x 18 W CFL (TC-DE)	₹ 2400
GCP 15218 SG	2 x 18 W CFL (TC-DE)	₹ 2250
GCP 15218 SGW	2 x 18 W CFL (TC-DE)	₹ 2800

Cutout dimensions: 180mm x 180mm

Cubix 16
GCP 16

Recess mounted low depth square downlighter with satin finish reflector and ribbed diffuser suitable for CFL lamps



GCP 16113	1 x 13 W CFL (TC-D)	₹ 1700
GCP 16118	1 x 18 W CFL (TC-D)	₹ 1700
GCP 16118 SGW	1 x 18 W CFL (TC-DE)	₹ 2400
GCP 16213	2 x 13 W CFL (TC-D)	₹ 2050
GCP 16218	2 x 18 W CFL (TC-D)	₹ 2050
GCP 16218 SGW	2 x 18 W CFL (TC-DE)	₹ 2750

Cutout dimensions: 180mm x 180mm

Commercial Interiors

Venus

WCP 27

Recess mounted low depth downlighter with frosted diffuser suitable for CFL lamps



WCP 27113/18	1 x 13/18 W CFL (TC-D)	₹ 1450
WCP 27118 SG	1 x 18 W CFL (TC-DE)	₹ 1650
WCP 27118 SGW	1 x 18 W CFL (TC-DE)	₹ 2200
WCP 27213/18	2 x 13/18 W CFL (TC-D)	₹ 1750
WCP 27218 SG	2 x 18 W CFL (TC-DE)	₹ 1950
WCP 27218 SGW	2 x 18 W CFL (TC-DE)	₹ 2500

Cutout dimensions: ø168mm

Venus

WCP 28

Recess mounted low depth downlighter with fresnel lens suitable for CFL lamps



WCP 28113/18	1 x 13/ 18 W CFL (TC-D)	₹ 1350
WCP 28118 SG	1 x 18 W CFL (TC-DE)	₹ 1550
WCP 28118 SGW	1 x 18 W CFL (TC-DE)	₹ 2100
WCP 28213/18	2 x 18 W CFL (TC-D)	₹ 1650
WCP 28218 SG	2 x 18 W CFL (TC-DE)	₹ 1850
WCP 28218 SGW	2 x 18 W CFL (TC-DE)	₹ 2400

Cutout dimensions: ø168mm

WCP 32 series

WCP 32

Recess mounted downlighter with specular finish reflector suitable for CFL lamps



WCP 32113	1 x 13 W CFL (TC-D)	₹ 1150
WCP 32118	1 x 18 W CFL (TC-D)	₹ 1150
WCP 32118 SG	1 x 18 W CFL (TC-DE)	₹ 1350
WCP 32118 SGW	1 x 18 W CFL (TC-DE)	₹ 1850
WCP 32213	2 x 13 W CFL (TC-D)	₹ 1450
WCP 32218	2 x 18 W CFL (TC-D)	₹ 1450
WCP 32218 SG	2 x 18 W CFL (TC-DE)	₹ 1600
WCP 32218 SGW	2 x 18 W CFL (TC-DE)	₹ 2200

Cutout dimensions: ø168mm

WCP 34 series

WCP 34

Recess mounted downlighter with fresnel lens suitable for CFL lamps



WCP 34113	1 x 13 W CFL (TC-D)	₹ 1450
WCP 34118	1 x 18 W CFL (TC-D)	₹ 1450
WCP 34118 SG	1 x 18 W CFL (TC-DE)	₹ 1600
WCP 34118 SGW	1 x 18 W CFL (TC-DE)	₹ 2100
WCP 34213	2 x 13 W CFL (TC-D)	₹ 1700
WCP 34218	2 x 18 W CFL (TC-D)	₹ 1700
WCP 34218 SG	2 x 18 W CFL (TC-DE)	₹ 1850
WCP 34218 SGW	2 x 18 W CFL (TC-DE)	₹ 2450

Cutout dimensions: ø168mm

WCP 36 series

WCP 36

Recess mounted downlighter with frosted glass suitable for CFL lamps



WCP 36113	1 x 13 W CFL (TC-D)	₹ 1700
WCP 36118	1 x 18 W CFL (TC-D)	₹ 1700
WCP 36118 SG	1 x 18 W CFL (TC-DE)	₹ 1850
WCP 36118 SGW	1 x 18 W CFL (TC-DE)	₹ 2350
WCP 36213	2 x 13 W CFL (TC-D)	₹ 1900
WCP 36218	2 x 18 W CFL (TC-D)	₹ 1900
WCP 36218 SG	2 x 18 W CFL (TC-DE)	₹ 2050
WCP 36218 SGW	2 x 18 W CFL (TC-DE)	₹ 2650

Cutout dimensions: ø168mm

WCP 37 series

WCP 37

Recess mounted downlighter with satin finish reflector and separate control gear box suitable for CFL lamps



WCP 37226	2 x 26 W CFL (TC-D)	₹ 2450
WCP 37226 SGW	2 x 26 W CFL (TC-DE)	₹ 3050

Cutout dimensions: ø215mm

WCP 42 series

WCP 42

Recess mounted downlighter with satin finish reflector suitable for CFL lamps



WCP 42113	1 x 13 W CFL (TC-D)	₹ 1150
WCP 42118	1 x 18 W CFL (TC-D)	₹ 1150
WCP 42118 SG	1 x 18 W CFL (TC-DE)	₹ 1300
WCP 42118 SGW	1 x 18 W CFL (TC-DE)	₹ 1800
WCP 42213	2 x 13 W CFL (TC-D)	₹ 1450
WCP 42218	2 x 18 W CFL (TC-D)	₹ 1450
WCP 42218 SG	2 x 18 W CFL (TC-DE)	₹ 1600
WCP 42218 SGW	2 x 18 W CFL (TC-DE)	₹ 2200

Cutout dimensions: ø168mm

WCP 39 series

WCP 39

Recess mounted downlighter with cross louvres suitable for CFL lamps



WCP 39213	2 x 13 W CFL (TC-D)	₹ 2050
WCP 39218	2 x 18 W CFL (TC-D)	₹ 2050
WCP 39218 SG	2 x 18 W CFL (TC-DE)	₹ 2200
WCP 39218 SGW	2 x 18 W CFL (TC-DE)	₹ 2800

Cutout dimensions: ø168mm



commercial interiors

Commercial Interiors

WCG/P 22 series

WCP 22

Recess mounted downlighter suitable for GLS/CFL lamps



WCG 22060	1 x 60 W GLS	₹ 550
WCP 22110	1 x 10 W CFL (TC-D)	₹ 950
WCP 22110 MF*	1 x 10 W CFL (TC-D)	₹ 950

*MF stands for Matt finish reflector

Cutout dimensions: ø110mm

WCP 23 series

WCP 23

Recess mounted downlighter – vertical lamp position suitable for CFL lamps



WCP 23113	1 x 13 W CFL (TC-D)	₹ 1000
WCP 23118	1 x 18 W CFL (TC-D)	₹ 1000
WCP 23118 SG	1 x 18 W CFL (TC-DE)	₹ 1150
WCP 23118 SGW	1 x 18 W CFL (TC-DE)	₹ 1650
WCP 23113 MF*	1 x 13 W CFL (TC-D)	₹ 1000
WCP 23118 MF*	1 x 18 W CFL (TC-D)	₹ 1000
WCP 23118 MF SG*	1 x 18 W CFL (TC-DE)	₹ 1150
WCP 23118 MF SGW*	1 x 18 W CFL (TC-DE)	₹ 1650

*MF stands for Matt finish reflector

Cutout dimensions: ø120mm

GCP 61

GCP 61

Surface mounted downlighter with frosted glass suitable for CFL lamps



new

GCP 61118 SG	1 x 18 W CFL (TC-DE)	₹ 2700
GCP 61218 SG	2 x 18 W CFL (TC-DE)	₹ 2950

Slim

GCF 30

Recess mounted wall washer suitable for FTL (T5) lamps



GCF 30128 SG	1 x 28 W FTL (T5)	₹ 2700
GCF 30128 SGW	1 x 28 W FTL (T5)	₹ 3100
GCF 30154 SGA	1 x 54 W FTL (T5)	₹ 4000

Cutout dimensions: 1190mm x 105mm



WVP 50

WVP 50

Recess mounted low glare mirror optic luminaire suitable for CFL lamps



WVP 50111	1 x 11 W CFL (TC-S)	₹ 1200
WVP 50211	2 x 11 W CFL (TC-S)	₹ 1400

Cutout dimensions: 278mm x 184mm



Compact

WCQ 21

Recess mounted dichroic halogen downlighter



WCQ 21150*	1 x 12V/50 W (Dichroic)	₹ 300
WBX 1350	Transformer	₹ 600

*Please order transformer separately

Cutout dimensions: ø57.5mm

WVP 41

WVP 41

Surface mounted low glare mirror optic luminaire suitable for CFL lamps



WVP 41111	1 x 11 W CFL (TC-S)	₹ 1450
WVP 41211	2 x 11 W CFL (TC-S)	₹ 1650
WVP 41218	2 x 18 W CFL (TC-L)	₹ 1750

WCH 50 series

WCH 50

Recess mounted downlighter suitable for MHL (HIT-DE) lamps



WCH 50070*	1 x 70 W MHL (HIT-DE)	₹ 1600
WCH 50150*	1 x 150 W MHL (HIT-DE)	₹ 1600
WGH 14070	Control gear box suitable for 1 x 70 W MHL	₹ 2450
WGH 14150	Control gear box suitable for 1 x 150 W MHL	₹ 3200

*Please order Control gear box (WGH 14070/ WGH 14150) separately

Cutout dimensions: ø168mm

Kompass Uno

GCH 351

Recess downlighter-single head suitable for MHL (HIT-CE) lamps



GCH 351*	1 x 35 W/ 70 W lamp (HIT- CE) - G12 base	₹ 2100
WGH 14035 T	Control Gear Box suitable for 1 x 35 W (HIT- CE) lamp	₹ 2550
WGH 14070 T	Control Gear Box suitable for 1 x 70 W (HIT- CE) lamp	₹ 2700

Cutout dimensions: 155mm x 155mm

*Please order Control Gear Box separately

Commercial Interiors

Kompass Duo

GCH 352

Recess mounted downlighter-twin head suitable for MHL (HIT-CE) lamps



GCH 352*	2 x 35 W /70W lamp (HIT-CE)- G12 base	₹ 3600
WGH 14035 T	Control Gear Box suitable for 1 x 35 W (HIT-CE) lamp	₹ 2550
WGH 14070 T	Control Gear Box suitable for 1 x 70 W (HIT-CE) lamp	₹ 2700

*Please order control gear box separately

Cutout dimensions: 155mm x 298mm

WCH 55 series

WCH 55

Recess mounted downlighter suitable for MHL (HIT-CE) lamps



WCH 55035*	1 x 35 W (HIT-CE) - G12 base	₹ 3900
WCH 55070*	1 x 70 W (HIT-CE) - G12 base	₹ 3900
WGH 14035 T	Control Gear Box suitable for 1 x 35 W (HIT-CE) lamp	₹ 2550
WGH 14070 T	Control Gear Box suitable for 1 x 70 W (HIT-CE) lamp	₹ 2700

*Please order control gear box separately

Cutout dimensions: ø175mm

Avio

GTH 40/41

GTH 40 - Track mounted projector with wide beam reflector



GTH 40035W	1 x 35 W CDMT (G-12)	₹ 10500
GTH 40070W	1 x 70 W CDMT (G-12)	₹ 10500
GTH 40035B	1 x 35 W CDMT (G-12)	₹ 10500
GTH 40070B	1 x 70 W CDMT (G-12)	₹ 10500

GTH 41 - Track mounted projector with narrow beam reflector

GTH 41035W	1 x 35 W CDMT (G-12)	₹ 10500
GTH 41070W	1 x 70 W CDMT (G-12)	₹ 10500
GTH 41035B	1 x 35 W CDMT (G-12)	₹ 10500
GTH 41070B	1 x 70 W CDMT (G-12)	₹ 10500

Suffix W stands for white colour and suffix B stands for black colour

Avio

GCH 42/43

GCH 42 - Surface mounted projector with wide beam reflector



GCH 42035W	1 x 35 W CDMT (G-12)	₹ 10300
GCH 42070W	1 x 70 W CDMT (G-12)	₹ 10300
GCH 42035B	1 x 35 W CDMT (G-12)	₹ 10300
GCH 42070B	1 x 70 W CDMT (G-12)	₹ 10300

GCH 43 - Track mounted projector with narrow beam reflector

GCH 43035W	1 x 35 W MHL (G-12)	₹ 10300
GCH 43070W	1 x 70 W MHL (G-12)	₹ 10300
GCH 43035B	1 x 35 W MHL (G-12)	₹ 10300
GCH 43070B	1 x 70 W MHL (G-12)	₹ 10300

Suffix W stands for white colour and suffix B stands for black colour



Rhythm
GRP 90/GRH 90

Pendant mounted luminaire with acrylic (PMMA) prismatic diffuser



GRP 90218	2 x 18 W CFL (TC-D)	₹ 7000
GRP 90218 SGW	2 x 18 W CFL (TC-DE)	₹ 7600
GRP 90226	2 x 26 W CFL (TC-D)	₹ 7200
GRP 90226 SGW	2 x 26 W CFL (TC-DE)	₹ 7550
GRH 90070	1 x 70 W MHL (E27)	₹ 8300

Rhythm
GRP 93/GRH 93

Pendant mounted luminaire with silverized spun aluminium diffuser



GRP 93218	2 x 18 W CFL (TC-D)	₹ 4500
GRP 93218 SGW	2 x 18 W CFL (TC-DE)	₹ 5150
GRP 93226	2 x 26 W CFL (TC-D)	₹ 4800
GRP 93226 SGW	2 x 26 W CFL (TC-DE)	₹ 5400
GRH 93070	1 x 70 W MHL (E27)	₹ 5800

Also available with 70W/150W HIT-CE (CDMT-G12) lamp with bottom enclosures

Commercial Interiors



Track – 3 Circuit



XTS 4100	Surface mounted track – 1m	₹ 2600
XTS 4200	Surface mounted track – 2m	₹ 5100
XTSF 4100	Recess mounted track – 1m	₹ 3600
XTSF 4200	Recess mounted track – 2m	₹ 7000

Suffix-2 for black color and -3 for white color (e.g. XTS4100-3 is a white color 1 m surface mounted track)

Module

HCF 85

Trunk mounted luminaire with symmetric distribution & with option for matt finish ribbed aluminium louvres



HCF 85228 W SGW	2 x 28 W FTL (T5)	₹ 2800
HCF 85254 W SGA	2 x 54 W FTL (T5)	₹ 4100

Track Accessories

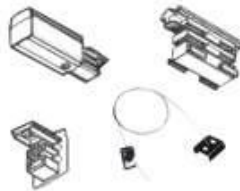

XTS 11	Power Feed - For powering track	₹ 1800
XTS 21	Straight Connector - For connecting two track	₹ 1150
XTS 41	End cap - For covering end of the track	₹ 300
SKB 110	Suspension - 1m (Contains only 1 suspension)	₹ 350
SKB120	Suspension - 2m (Contains only 1 suspension)	₹ 400

Suffix-2 for black color and -3 for white color (e.g. XTS11-3 is a white color power feed)

Module Trunk

WCX 11/21 & WCX 13/23

Trapezoid shaped robust construction with wiring harness, cover plate and standard 1m suspension

WCX 11770	Extruded aluminium trunk - 1.77m	₹ 2700
WCX 13540	Extruded aluminium trunk - 3.54m	₹ 5550
WCX 21770	CRCA trunk - 1.77m	₹ 2200
WCX 23540	CRCA trunk - 3.54m	₹ 4350

Indoor Decorative

Coral

WRF 80/81

Indoor decorative luminaire suitable for FTL (T5)/(T8) lamps



WRF 80136 SG	1 x 36 W FTL (T8)	₹ 1050
WRF 80128 SG	1 x 28 W FTL (T5)	₹ 1100
WRF 81136 SG	1 x 36 W FTL (T8) with serrated diffuser	₹ 1150
WRF 81128 SG	1 x 28 W FTL (T5) with serrated diffuser	₹ 1200

Pearl

WRF 20

Indoor decorative luminaire with end caps and coloured rims suitable for FTL (T8) lamps



WRF 20120	1 x 20 W FTL (T8)	₹ 900
WRF 20140	1 x 40 W FTL (T8)	₹ 1050
WRF 20140 SG	1 x 40 W FTL (T8)	₹ 1400

Suffix ZZRZ to Cat no. for Red colour rims and Suffix ZBZB to Cat no. for Blue colour rims

Pearl

WRF 21/WRP 21

Indoor decorative luminaire with opal acrylic diffuser, end caps and coloured rims suitable for FTL (T8) and CFL (TC-S) lamps



WRF 21118	1 x 18 W FTL (T8)	₹ 1000
WRF 21136	1 x 36 W FTL (T8)	₹ 1250
WRF 21136 SG	1 x 36 W FTL (T8)	₹ 1450
WRP 21111	1 x 11W CFL (TC-S)	₹ 750

Suffix ZZRZ to Cat no. for Red colour rims and Suffix ZBZB to Cat no. for Blue colour rims



commercial interiors

Patti

WDF 91

Functional patti suitable for FTL (T8)/(T5) lamps



WDF 9140	1 x 40 W FTL (T8)	₹ 700
WDF 9140 SG	1 x 40 W FTL (T8)	₹ 1100
WDF 9120	1 x 20 W FTL (T8)	₹ 600
WDF 9128 SG	1 x 28 W FTL (T5)	₹ 1100
WDF 9114 SGW	1 x 14 W FTL (T5)	₹ 1400

Industries



Good lighting for industries needs specially designed luminaires to suit specific environment and are easy to maintain



**rugged,
efficient &
long-lasting**



Indi.X
WHF 38



Enclosed integral midbay and highbay luminaires with specially designed reflectors and unique heat management system

WHF 38428 SGW	4 x 28 W FTL (T5) enclosed-narrow beam	₹ 9750
WHF 38628 SGW	6 x 28 W FTL (T5) enclosed-narrow beam	₹ 12700
WHF 38454 SGA	4 x 54 W FTL (T5) enclosed-narrow beam	₹ 10500

industries

Indinxt
WHF 31/32

Integral midbay and highbay luminaires with specially designed reflectors and unique heat management system



WHF 31428 SGW	4 x 28 W FTL (T5) open-wide beam	₹ 8500
WHF 31454 SGA	4 x 54 W FTL (T5) open-wide beam	₹ 9500
WHF 32428 SGW	4 x 28 W FTL (T5) open-narrow beam	₹ 8500
WHF 32454 SGA	4 x 54 W FTL (T5) open-narrow beam	₹ 9500

Indinxt
WHF 33/34

Enclosed integral midbay and highbay luminaires with specially designed reflectors and unique heat management system



WHF 33428 SGW	4 x 28 W FTL (T5) enclosed-wide beam	₹ 11000
WHF 33454 SGA	4 x 54 W FTL (T5) enclosed-wide beam	₹ 12000
WHF 34428 SGW	4 x 28 W FTL (T5) enclosed-narrow beam	₹ 11000
WHF 34454 SGA	4 x 54 W FTL (T5) enclosed-narrow beam	₹ 12000

Industries



Indibay

WHF 30

Integral midbay and highbay range of luminaires with specially designed reflectors



WHF 30428 SGW	4 x 28W FTL (T5) open version	₹ 7650
WHF 30428 SGA	4 x 28W FTL (T5) open version	₹ 8750
WHF 30454 SGA	4 x 54W FTL (T5) open version	₹ 9000

Zip

WIF 90

Compact energy saving channel suitable for FTL (T5/T8) lamps



WIF 90128 SG	1 x 28 W FTL (T5)	₹ 1200
WIF 90228 SG	2 x 28 W FTL (T5)	₹ 1600
WIF 90136 SG	1 x 36 W FTL (T8)	₹ 1050
WIF 90236 SG	2 x 36 W FTL (T8)	₹ 1600

Zip

WIF 91

Compact energy saving channel with bi-directional reflector suitable for FTL (T5/T8) lamps



WIF 91128 SG	1 x 28 W FTL (T5)	₹ 1450
WIF 91228 SG	2 x 28 W FTL (T5)	₹ 1900
WIF 91136 SG	1 x 36 W FTL (T8)	₹ 1400
WIF 91236 SG	2 x 36 W FTL (T8)	₹ 1900

eg: For 28 W channel with bi-directional reflector - WIF 91228 SG following are the subcodes HIF 91128 W SG (housing) and WIR 91228 (reflector)

Saviour

WIF 20

Slim energy saving channel suitable for FTL (T5) lamps



WIF 20128 SG	1 x 28 W FTL (T5)	₹ 1250
WIF 20128 SGW	1 x 28 W FTL (T5)	₹ 1700
WIF 20228 SG	2 x 28 W FTL (T5)	₹ 1700
WIF 20228 SGW	2 x 28 W FTL (T5)	₹ 2100

Saviour

WIF 30

Slim energy saving channel suitable for FTL (T5) lamps with bi-directional reflector



WIF 30128 SG	1 x 28 W FTL (T5)	₹ 1500
WIF 30128 SGW	1 x 28 W FTL (T5)	₹ 1900
WIF 30228 SG	2 x 28 W FTL (T5)	₹ 1900
WIF 30228 SGW	2 x 28 W FTL (T5)	₹ 2300

eg: For 28 W channel with bi-directional reflector - WIF 30128 SG following are the subcodes HIF 30128 W SG (housing) and WIR 30128 (reflector)

Ray
WIF 50

Slim energy efficient fluorescent channel suitable for FTL (T5/T8) lamps



new

WIF 50128 SG	1 x 28 W FTL (T5)	₹ 975
WIF 50136 SG	1 x 36 W FTL (T8)	₹ 850

RAY
MULTI-PURPOSE FLUORESCENT CHANNEL



multi-purpose fluorescent channel

Ray is best suited for multiple applications like industries, warehouses, storage areas, parking areas and aisles.

Optima
WIF 14

Industrial channel with pre-coated sheet steel suitable for FTL (T8) lamps



WIF 14140	1 x 36/40 W FTL (T8)	₹ 1100
WIF 14140 SG	1 x 36/40 W FTL (T8)	₹ 1250
WIF 14140 SGW	1 x 36/40 W FTL (T8)	₹ 1650

Optima
WIF 14

Industrial channel with pre-coated sheet steel suitable for FTL (T8) lamps



WIF 14240	2 x 36/40 W FTL (T8)	₹ 1600
WIF 14240 SG	2 x 36/40 W FTL (T8)	₹ 1700
WIF 14240 SGW	2 x 36/40 W FTL (T8)	₹ 2100

Optima
WIF 36

Slim channel with bi-directional reflector suitable for FTL (T8) lamps



WIF 36140 S	1 x 36/40 W FTL (T8)	₹ 1550
WIF 36140 SGS	1 x 36/40 W FTL (T8)	₹ 1650
WIF 36140 SGWS	1 x 36/40 W FTL (T8)	₹ 2050

eg: For 40 W channel with bi-directional reflector - WIF 36140 S following are the subcodes HIF 36140 NS (housing) and WIR 36 S (reflector)

Optima
WIF 36

Slim channel with bi-directional reflector suitable for FTL (T8) lamps



WIF 36240 S	2 x 36/40 W FTL (T8)	₹ 1850
WIF 36240 SGS	2 x 36/40 W FTL (T8)	₹ 2100
WIF 36240 SGWS	2 x 36/40 W FTL (T8)	₹ 2500

eg: For 36 W channel with bi-directional reflector - WIF 36240 SGS following are the subcodes HIF 36240 W SG (housing) and WIR 36 S (reflector)

industries

Industries

WCF 12 series

WCF 12

Industrial fluorescent channel suitable for FTL (T8) lamps



WCF 12136	1 x 36 W FTL (T8)	₹ 1150
WCF 12136 SG	1 x 36 W FTL (T8)	₹ 1250
WCF 12136 SGW	1 x 36 W FTL (T8)	₹ 1650

WCF 12 series

WCF 12

Industrial fluorescent channel suitable for FTL (T8) lamps



WCF 12236	2 x 36 W FTL (T8)	₹ 1650
WCF 12236 SG	2 x 36 W FTL (T8)	₹ 1750
WCF 12236 SGW	2 x 36 W FTL (T8)	₹ 2050

WCF 26 series

WCF 26

Industrial fluorescent channel with stove enamelled reflector suitable for FTL (T8) lamps



WCF 26136	1 x 36 W FTL (T8)	₹ 1750
WCF 26136 SG	1 x 36 W FTL (T8)	₹ 1850
WCF 26136 SGW	1 x 36 W FTL (T8)	₹ 2200

eg: For 36 W channel with stove enamelled reflector - WCF 26136 SG following are the subcodes WCF 12136 SG (housing) and WIR 26 (reflector)

Please add Rs. 800 to the above prices for fixtures with VE reflectors (WCF 41)

WCF 26 series

WCF 26

Industrial fluorescent channel with stove enamelled reflector suitable for FTL (T8) lamps



WCF 26236	2 x 36 W FTL (T8)	₹ 2300
WCF 26236 SG	2 x 36 W FTL (T8)	₹ 2400
WCF 26236 SGW	2 x 36 W FTL (T8)	₹ 2750

eg: For 36 W channel with stove enamelled reflector - WCF 26236 SG following are the subcodes WCF 12236 SG (housing) and WIR 26 (reflector)

Please add Rs. 800 to the above prices for fixtures with VE reflectors (WCF 41)

Capsule

WIF 83

IP 65 industrial corrosion proof luminaire suitable for FTL (T5) lamps



WIF 83114 SGW	1 x 14 W FTL (T5)	₹ 2000
WIF 83128 SG	1 x 28 W FTL (T5)	₹ 3200
WIF 83128 SGW	1 x 28 W FTL (T5)	₹ 3650
WIF 83128 SGA	1 x 28 W FTL (T5)	₹ 4000
WIF 83154 SGA	1 x 54 W FTL (T5)	₹ 4150

Capsule

WIF 83

IP 65 industrial corrosion proof luminaire suitable for FTL (T5) lamps



WIF 83228 SG	2 x 28 W FTL (T5)	₹ 4600
WIF 83228 SGW	2 x 28 W FTL (T5)	₹ 4750
WIF 83228 SGA	2 x 28 W FTL (T5)	₹ 5100
WIF 83254 SGA	2 x 54 W FTL (T5)	₹ 5250

Capsule

WIF 83

IP 65 industrial corrosion proof
luminaire suitable for FTL (T8) lamps



WIF 83136	1 x 36 W FTL (T8)	₹ 3250
WIF 83136 SG	1 x 36 W FTL (T8)	₹ 3400
WIF 83136 SGW	1 x 36 W FTL (T8)	₹ 3750
WIF 83136 SGA	1 x 36 W FTL (T8)	₹ 4350

Capsule

WIF 83

IP 65 industrial corrosion proof
luminaire suitable for FTL (T8) lamps



WIF 83236	2 x 36 W FTL (T8)	₹ 4250
WIF 83236 SG	2 x 36 W FTL (T8)	₹ 4350
WIF 83236 SGW	2 x 36 W FTL (T8)	₹ 4750
WIF 83236 SGA	2 x 36 W FTL (T8)	₹ 5150



Kube

WHM/S 68

Integral wide beam midbay
luminaire with aluminium reflector



WHM 68250	1 x 250 W HPMV	₹ 5600
WHS 68150	1 x 150 W HPSV (E)	₹ 5000
WHS 68250	1 x 250 W HPSV (E)	₹ 5700

eg: For 250 W integral midbay luminaire with aluminium reflector- WHS 68250 following are the subcodes
HHS 68250 (housing), WHR 28 (reflector), and WBS/H 56250 SL31 (ballast)

Kube

WHM/S 69

Integral highbay luminaire with
aluminium reflector



WHM 69250	1 x 250 W HPMV	₹ 6150
WHM 69400	1 x 400 W HPMV	₹ 6700
WHS 69250	1 x 250 W HPSV (E)	₹ 6200
WHS 69400	1 x 400 W HPSV (E)	₹ 7250

eg: For 400 W integral highbay luminaire with aluminium reflector WHS 69400 following are the subcodes
HHS 69400 (housing), WHR 69 (reflector), and WBS/H 56400 (ballast)

Industries

Kube WHM/S/H 78

Enclosed wide beam integral midbay luminaire with aluminium reflector



WHM 78250	1 x 250 W HPMV	₹ 6350
WHS 78150	1 x 150 W HPSV (E)	₹ 6000
WHS 78250	1 x 250 W HPSV (E)	₹ 6500
WHH 78250 SL60	1 x 250 W MHL (E) [WLH 250W/E/MB/N]	₹ 6150
WHH 78250	1 x 250 W MHL (E)	₹ 6500

eg: For 250 W enclosed integral midbay luminaire with aluminium reflector - WHS 78250 following are the subcodes, HHS 78250 (housing), WHR 28 (reflector), WHA 78 (glass) and WBS/H 56250 SL31 (ballast)

Technik WHM/S 28

Integral midbay luminaire with aluminium reflector



WHM 28250	1 x 250 W HPMV	₹ 5950
WHS 28150	1 x 150 W HPSV (E)	₹ 5750
WHS 28250	1 x 250 W HPSV (E)	₹ 6450

eg: For 250 W integral midbay luminaire with aluminium reflector - WHS 28250 following are the subcodes HHS 28250 (housing), WHR 28 (reflector) and WBS/H 56250 SL31 (ballast)

Technik WHM/S 25

Integral highbay wide beam luminaire with aluminium reflector



WHM 25250	1 x 250 W HPMV	₹ 6700
WHM 25400	1 x 400 W HPMV	₹ 7300
WHS 25250	1 x 250 W HPSV (E)	₹ 7200
WHS 25400	1 x 400 W HPSV (E)	₹ 8300

eg: For 250 W integral highbay luminaire with aluminium reflector - WHS 25250 following are the subcodes HHS 25250 (housing), WHR 25 (reflector) and WBS/H 56250 SL31 (ballast)

Kube WHM/S/H 79

Enclosed integral highbay luminaire with aluminium reflector



WHM 79250	1 x 250 W HPMV	₹ 7500
WHM 79400	1 x 400 W HPMV	₹ 8100
WHS 79250	1 x 250 W HPSV (E)	₹ 7500
WHS 79400	1 x 400 W HPSV (E)	₹ 8550
WHH 79250 SL60	1 x 250 W MHL (E)[WLH 250W/E/MB/N]	₹ 7150
WHH 79250	1 x 250 W MHL (E)	₹ 7500
WHH 79400 SL60	1 x 400 W MHL (E)[WLH 400W/E/MB/N]	₹ 7800
WHH 79400	1 x 400 W MHL (E)	₹ 8550

eg: For 400 W enclosed integral highbay luminaire with aluminium reflector - WHH 79400 following are the subcodes HHH 79250 (housing), WHR 79 (reflector), WHA 79 (glass) and WBS/H 56250 SL31 (ballast)



Technik

WHM/S/H 65

Enclosed highbay wide beam luminaire with aluminium reflector



WHM 65250	1 x 250 W HPMV	₹ 8000
WHM 65400	1 x 400 W HPMV	₹ 9050
WHS 65250	1 x 250 W HPSV (E)	₹ 8400
WHS 65400	1 x 400 W HPSV (E)	₹ 9550
WHH 65250 SL60	1 x 250 W MHL (E) [WLH 250W/E/MB/N]	₹ 8000
WHH 65250	1 x 250 W MHL (E)	₹ 8350
WHH 65400 SL60	1 x 400 W MHL (E) [WLH 400W/E/MB/N]	₹ 8750
WHH 65400	1 x 400 W MHL (E)	₹ 9550

eg: For 400 W enclosed integral highbay luminaire with aluminium reflector - WHH 65400 following are the subcodes
HHH 65400 (housing), WHR 25 (reflector), WHA 65 (glass) and WBS/H 56400 (ballast)

Technik

WHM/S/H 66

Enclosed midbay luminaire with aluminium reflector



WHM 66250	1 X 250 W HPMV	₹ 7550
WHS 66250	1 x 250 W HPSV (E)	₹ 7750
WHH 66150	1 x 150 W MHL (E)	₹ 6900
WHH 66250 SL60	1 x 250 W MHL (E) [WLH 250W/E/MB/N]	₹ 7400
WHH 66250	1 x 250 W MHL (E)	₹ 7750

eg: For 250 W enclosed integral midbay luminaire with aluminium reflector - WHH 66250 following are the subcodes
HHH 66250 (housing), WHR 28 (reflector), WHA 66 (glass) and WBS/H 56250 SL31 (ballast)

Radbay

WHM/S/H 48

IP 65 totally enclosed integral vertical mounted highbay luminaire



WHM 48250	1 x 250 W HPMV	₹ 7300
WHM 48400	1 x 400 W HPMV	₹ 7800
WHS 48150	1 x 150 W HPSV (E)	₹ 6950
WHS 48250	1 x 250 W HPSV (E)	₹ 7450
WHS 48400	1 x 400 W HPSV (E)	₹ 8450
WHH 48250 SL60	1 x 250 W MHL (E) [WLH 250W/E/MB/N]	₹ 7050
WHH 48250	1 x 250 W MHL (E)	₹ 7450
WHH 48400 SL60	1 x 400 W MHL (E) [WLH 400W/E/MB/N]	₹ 7600
WHH 48400	1 x 400 W MHL (E)	₹ 8400

eg: For 400 W integral enclosed highbay luminaire with aluminium reflector - WHH 48400 following are the subcodes
HHH 48400 (housing), WHR 48 (reflector), WHA 48 (glass) and WBS/H 56400 (ballast)

Radbay

WHM/S/H 49

IP 65 totally enclosed integral vertical mounted midbay luminaire



WHM 49250	1 x 250 W HPMV	₹ 7300
WHS 49150	1 x 150 W HPSV (E)	₹ 6650
WHS 49250	1 x 250 W HPSV (E)	₹ 7150
WHH 49250 SL60	1 x 250 W MHL (E) [WLH 250W/E/MB/N]	₹ 6800
WHH 49250	1 x 250 W MHL (E)	₹ 7150

eg: For 250 W integral enclosed midbay luminaire with aluminium reflector - WHH 49250 following are the subcodes
HHH 48250 (housing), WHR 49 (reflector), WHA 49 (glass) and WBS/H 56250 SL31 (ballast)

industries

Industries



Lowbay

WHH 96/98

IP 65 totally enclosed integral lowbay luminaire



WHH 96070 S	1 x 70 W MHL (double ended)	₹ 6050
WHH 96150 S	1 x 150 W MHL (double ended)	₹ 6700
WHH 98250 S	1 x 250 W MHL (T)	₹ 7950

eg: For 250 W enclosed integral lowbay luminaire - WHH 98250 S following are the subcodes HHH 96150 S (housing) and WBS/H 56250 SL31 (ballast)

Neo

WHH 91

Integral totally enclosed lowbay luminaire suitable for Metal Halide Lamps – MHL (Double ended)



WHH 91070	Symmetric 1 x 70 W MHL/CDMT (double ended)	₹ 6400
WHH 91150	Symmetric 1 x 150 W MHL/CDMT (double ended)	₹ 6950

eg: For 150 W enclosed integral lowbay luminaire - WHH 91150 following are the subcodes HHH 91150 (housing) and WBS/H 56150 SL31 (ballast)

Wellglass

WWP 62

IP 65 integral wellglass luminaire suitable for CFL (TC-D)/TC-DE) lamps



WWP 62218	2 x 18 W CFL (TC-D)	₹ 2450
WWP 62218 SG	2 x 18 W CFL (TC-DE)	₹ 2850

For above fixture with stove enamelled reflector (WWP 63218) add Rs. 350/- to the above prices.
For above fixture with vitreous enamelled reflector (WWP 64218) add Rs. 475/- to the above prices.

Wellglass

WWM 54

IP 65 integral wellglass luminaire



WWM 54080*	1 x 80 W HPMV (BC lampholder)	₹ 3600
WWM 54125*	1 x 125W HPMV (BC lampholder)	₹ 3700

eg: For 80 W integral wellglass luminaire - WWM 54080 following are the subcodes HWM 54080 (housing) and WBM 16080 (ballast)

*Incase required with ES cap, suffix ES to cat. no. For above fixture with stove enamelled reflector (WWM 52080/52125) add Rs. 350/- to the above prices. For above fixture with vitreous enamelled reflector (WWM 53080/53125) add Rs. 475/- to the above prices.

Wellglass
WWS/H 62

IP 65 integral wellglass luminaire suitable for HPSV & MHL lamps



WWS 62070	70 W HPSV (E) with internal starter	₹ 3100
WWS 62071	70 W HPSV (E) without internal starter	₹ 3300
WWH 62070	70 W MHL (E)	₹ 3300

eg: For 70 W integral wellglass luminaire - WWS 62070 following are the subcodes
HWS 62070 (housing) and WBS/H 57070 SL31 (ballast)
For above fixture with stove enamelled reflector (WWS/H 63070/71) add Rs. 350/- to the above prices.
For above fixture with vitreous enamelled reflector (WWS/H 64070/71) add Rs. 475/- to the above prices.

Wellglass
WWS/H 60

IP 65 integral wellglass luminaire suitable for HPSV & MHL lamps



WWS 60150	150 W HPSV (E)	₹ 5400
WWH 60150	150 W MHL (E)	₹ 5400

eg: For 150 W integral wellglass luminaire - WWS 60150 following are the subcodes
HWS 62150 (housing) and WBS/H 57150 SL31 (ballast)
For above fixture with stove enamelled reflector (WWS/H 61150) add Rs. 350/- to the above prices.
For above fixture with vitreous enamelled reflector (WWS/H 61150 VE) add Rs. 475/- to the above prices.

Wellglass
WWG/M/S 10

IP 65 non-integral wellglass luminaire



WWG 10100	1 x 100 W GLS	₹ 1750
WWM 10080*	1 x 80 W HPMV (BC lampholder)	₹ 1850
WWM 10125	1 x 125 W HPMV (BC lampholder)	₹ 1850
WWS 10070	1 x 70 W HPSV (E) with internal starter	₹ 1850

*Incense required with E5 cap, suffix E5 to cat. no. For above fixture with stove enamelled reflector (WWR 11) add Rs. 500/- to the above prices. For above fixture with vitreous enamelled reflector (WWR 12) add Rs. 575/- to the above prices. Note: Please order suitable control gear box from pg 77

Wellglass
WWM/S 30

IP 65 non-integral wellglass luminaire



WWM 30250	1 x 250 W HPMV	₹ 2400
WWS 30150	1 x 150 W HPSV (E)	₹ 2400

For above fixture with stove enamelled reflector (WWR 31)add Rs. 500/-to the above prices.
For above fixture with vitreous enamelled reflector (WWR 32)add Rs. 575/- to the above prices.
Note: Please order suitable control gear box from page 77

WKP 14
WKP 14

CFL bulk head



WKP 14109	1 x 9 W CFL (TC-S)	₹ 1100
-----------	--------------------	--------

WKG 13
WKG 13

Industrial bulk head with glass dome and wire guard



WKG 13	1 x 40 / 60 / 100 W GLS	₹ 650
--------	-------------------------	-------

Cleanroom & Sterile Areas



Vision

WIP 43

IP 54 recess mounted bottom opening type cleanroom luminaire suitable for CFL (TC-L) lamps



WIP 43236	2 x 36 W CFL (TC- L)	₹ 6800
WIP 43236 SG	2 x 36 W CFL (TC- L)	₹ 7000
WIP 43236 SGW	2 x 36 W CFL (TC- L)	₹ 7350
WIP 43236 SGA	2 x 36 W CFL (TC- L)	₹ 7650
Cutout dimension: 581mm x 581mm		

Vision

WIP 43

IP 54 recess mounted bottom opening type cleanroom luminaire suitable for CFL (TC-L) lamps



WIP 43336	3 x 36 W CFL (TC- L)	₹ 7650
WIP 43336 SG	3 x 36 W CFL (TC- L)	₹ 7850
WIP 43336 SGW	3 x 36 W CFL (TC- L)	₹ 8700
WIP 43336 SGA	3 x 36 W CFL (TC- L)	₹ 9250
Cutout dimension: 581mm x 581mm		

Vision
WIF 42

IP 54 recess mounted bottom opening type cleanroom luminaire suitable for FTL (T8) lamps



WIF 42236	2 x 36 W FTL (T8)	₹ 6000
WIF 42236 SGW	2 x 36 W FTL (T8)	₹ 6550
WIF 42236 SGA	2 x 36 W FTL (T8)	₹ 6850

Cutout dimension: 1240mm x 240mm

vision+



revolutionary cleanroom luminaire

Vision+ is a uniquely engineered top openable cleanroom luminaire. The innovative design of this luminaire gives flexibility and ease of installation.

For any queries on cleanroom lighting applications, contact our nearest branch or write to helpdesk.lighting@wipro.com

Vision
WIP 53

IP 54 surface mounted bottom opening type cleanroom luminaire suitable for CFL (TC-L) lamps



WIP 53236	2 x 36 W CFL (TC-L)	₹ 6600
WIP 53236 SG	2 x 36 W CFL (TC-L)	₹ 6800
WIP 53236 SGW	2 x 36 W CFL (TC-L)	₹ 7100
WIP 53236 SGA	2 x 36 W CFL (TC-L)	₹ 7600

Vision
WIP 53

IP 54 surface mounted bottom opening type cleanroom luminaire suitable for CFL (TC-L) lamps



WIP 53336	3 x 36 W CFL (TC-L)	₹ 7400
WIP 53336 SG	3 x 36 W CFL (TC-L)	₹ 7800
WIP 53336 SGW	3 x 36 W CFL (TC-L)	₹ 8300
WIP 53336 SGA	3 x 36 W CFL (TC-L)	₹ 9700

cleanroom & sterile areas

Vision
WIF 52

IP 54 surface mounted bottom opening type cleanroom luminaire suitable for FTL (T8) lamps



WIF 52236	2 x 36 W FTL (T8)	₹ 6200
WIF 52236 SG	2 x 36 W FTL (T8)	₹ 6300
WIF 52236 SGW	2 x 36 W FTL (T8)	₹ 6650
WIF 52236 SGA	2 x 36 W FTL (T8)	₹ 7050



Street & Flood



experience
safer &
more enjoyable
illuminated
outdoors

Good lighting in
outdoors is having
precision in optical design
& uniformity in light
enhancing safety
& security



Winner of prestigious India Design Mark & European Design Award

timeless elegance in a designer streetlight

Vola's international appeal, minimalistic elegance and sleek lines underline a powerful design character. It represents a design that is neutral, elegant and timeless. The use of high quality materials, exquisite finishes and minute detailing create a statement in urban street lighting

street & flood

unique, multi-faceted reflector design

The small segments of the reflector directs light in multiple directions delivering a wider and uniform light distribution. The finish of the reflector is perfected with high reflective materials that add to the efficiency and longevity of the luminaire

**PATENT
APPLIED FOR**

Vola WST/H 51

IP 66 high performance designer streetlight

WST 51150	1 x 150 W HPSV (T)	₹ 30000
WST 51250	1 x 250 W HPSV (T)	₹ 30500
WSH 51250	1 x 250 W MHL (T)	₹ 30500

eg: For 250 W Vola- WST 51250 following are the subcodes
HST 51250 (housing) and WBS/H 56250 SL31 (ballast)

Street & Flood



Enzo

WST/H 40

IP 66 die-cast aluminium top maintainable streetlight with curved toughened glass & pot optics reflector



WST 40150	1 x 150 W HPSV (T)	₹ 9600
WST 40250	1 x 250 W HPSV (T)	₹ 10250
WSH 40150	1 x 150 W MHL (T) Lamp base E40	₹ 9600
WSH 40250	1 x 250 W MHL (T)	₹ 10250

eg: For 250 W Enzo – WST 40250 following are the subcodes
HSZ 40 (housing), HGT 40250 (gear tray) and WBS/H 56250 SL31 (ballast)

Duro

WST/H 41

IP 66 die-cast aluminium top maintainable streetlight with curved toughened glass & pot optics reflector



WST 41150	1 x 150 W HPSV (T)	₹ 9600
WST 41250	1 x 250 W HPSV (T)	₹ 10250
WSH 41150	1 x 150 W MHL (T) Lamp base E40	₹ 9600
WSH 41250	1 x 250 W MHL (T)	₹ 10250

eg: For 250 W Duro – WST 41250 following are the subcodes
HSZ 41 (housing), HGT 41250 (gear tray) and WBS/H 56250 SL31 (ballast)

Aero

WST/H 42

IP 66 die-cast aluminium top maintainable streetlight with curved toughened glass & pot optics reflector



WST 42150	1 x 150 W HPSV (T)	₹ 13350
WST 42250	1 x 250 W HPSV (T)	₹ 14100
WST 42400	1 x 400 W HPSV (T)	₹ 15350
WSH 42250	1 x 250 W MHL (T)	₹ 14100
WSH 42400	1 x 400 W MHL (T)	₹ 15350

eg: For 400 W Aero – WST 42400 following are the subcodes
HSZ 42 (housing), HGT 42400 (gear tray) and WBS/H 56400 (ballast)

Uno

WST/H 71

IP 66 die-cast aluminium top maintainable streetlight with curved toughened glass & pot optics reflector with an IP 54 control gear box compartment



WST 71150	1 x 150 W HPSV (T)	₹ 10000
WST 71250	1 x 250 W HPSV (T)	₹ 10550
WSH 71150	1 x 150 W MHL (T) Lamp base E40	₹ 10000
WSH 71250	1 x 250 W MHL (T)	₹ 10550

eg: For 250 W Uno – WST 71250 following are the subcodes
HSZ 71 (housing), HGT 71250 (gear tray) and WBS/H 56250 SL31 (ballast)

Cruze
WST/H 50

IP 66 bottom opening die-cast aluminium integral streetlight



WST 50070	1 x 70 W HPSV (T)	₹ 6000
WST 50150	1 x 150 W HPSV (T)	₹ 6900
WST 50250	1 x 250 W HPSV (T)	₹ 7900
WSH 50150	1 x 150 W MHL (T) Lamp base E40	₹ 6900
WSH 50250	1 x 250 W MHL (T)	₹ 7900

eg: For 250 W Cruze – WST 50250 following are the subcodes
HST 50250 (housing) and WBS/H 56250 SL31 (ballast)

Lumino
WST/H 45

IP 65 die-cast aluminium streetlight



WST 45150	1 x 150 W HPSV (T)	₹ 6700
WST 45250	1 x 250 W HPSV (T)	₹ 7700
WSH 45150	1 x 150 W MHL (T) Lamp base E40	₹ 6700
WSH 45250	1 x 250 W MHL (T)	₹ 7700

eg: For 250 W Lumino – WST 45250 following are the subcodes
HST/H 45250 (housing) and WBS/H 56250 SL31 (ballast)

Express
WSM/S/H 24

IP 65 pot optics silverised finish streetlight



WSM 24080*	1 x 80 W HPMV (BC lampholder)	₹ 3950
WSM 24125*	1 x 125 W HPMV (BC lampholder)	₹ 4150
WSS 24070	1 x 70 W HPSV (E) with internal starter	₹ 4150
WSS 24071	1 x 70 W HPSV (E) without internal starter	₹ 4350
WST 24071	1 x 70 W HPSV (T) Lamp base E27	₹ 4350
WSH 24070	1 x 70 W MHL (T)	₹ 4350

eg: For 80 W Express – WSM 24080 following are the subcodes
HSM 24080 (housing) and WBM 15080 (ballast). * in case required with ES cap, suffix ES to the cat no.

Express
WST/H 25

IP 65 pot optics silverised finish streetlight



WST 25150	1 x 150 W HPSV (T)	₹ 4950
WST 25250	1 x 250 W HPSV (T)	₹ 6400
WSH 25150	1 x 150 W MHL (T) Lamp base E40	₹ 4950
WSH 25250	1 x 250 W MHL (T)	₹ 6400

eg: For 150 W Express – WST 25150 following are the subcodes
HST 25150 S (housing) and WBS/H 56150 SL31 (ballast)

Verve
WSF 12

IP 65 sleek and trendy FTL (T5) streetlight



WSF 12414 SGW	4 x 14 W FTL (T5)	₹ 7150
WSF 12424 SGA	4 x 24 W FTL (T5)	₹ 8000

Lumino
WSF 14

IP 65 sleek and efficient FTL (T5) streetlight



WSF 14214 SG	2 x 14 W FTL (T5)	₹ 3500
WSF 14224 SG	2 x 24 W FTL (T5)	₹ 3650

street & flood

Street & Flood



Lumino

WSF 14

IP 65 sleek and efficient FTL (T5) streetlight



WSF 14414 SG	4 x 14 W FTL (T5)	₹ 6350
WSF 14424 SG	4 x 24 W FTL (T5)	₹ 6600

Lumino

WSF 14

IP 43 fluorescent streetlight



WSF 14128 SG	1 x 28 W FTL (T5)	₹ 2150
WSF 14136 SG	1 x 36 W FTL (T8)	₹ 2300

Lumino

WSP 13

IP 65 compact fluorescent streetlight



WSP 13236 SG	2 x 36 W CFL (TC-L)	₹ 3200
WSP 13336 SG	3 x 36 W CFL (TC-L)	₹ 5400

WSP 16

WSP 16

Secondary road CFL streetlight



WSP 16136	1 x 36 W CFL (TC-L)	₹ 2050
WSP 16136 SG	1 x 36 W CFL (TC-L)	₹ 2350

WPM/S 27 series

WPM/S 27

Integral post top



WPM 27080*	1 x 80 W HPMV (BC lampholder)	₹ 4850
WPM 27125*	1 x 125 W HPMV (BC lampholder)	₹ 4950
WPS 27070	1 x 70 W HPSV (E) (with internal starter)	₹ 4800
WPS 27071	1 x 70 W HPSV (E) (without internal starter)	₹ 4950

eg: For 125 W integral post top – WPM 27125 following are the subcodes
HPM 27125 (housing), WPD 25 and WBM 15125 (ballast)

* in case required with ES cap, suffix ES to the cat no.



Vivo
WFZ 53

IP 65 integral floodlight with symmetric wide beam distribution

new

WFZ 53070	1 x 70 W MHL(DE) double ended	₹ 5700
WFZ 53150	1 x 150 W MHL(DE) double ended	₹ 6600
WFZ 53250	1 x 250 W MHL (T)/MHL (T) double ended	₹ 7800
WFZ 53400	1 x 400 W MHL (T)/MHL (T) double ended	₹ 8800

eg: For 250 W Vivo – WFZ 53250 following are the subcodes
HFZ 53 (housing), HGH 53250 and WBS/H 56250 SL31 (ballast)

WFZ 42
WFZ 42

IP 65 non-integral symmetric floodlight with wide beam reflector

WFZ 42250	1 x 250 W HPSV (T)/MHL (T)	₹ 4400
WFZ 42400	1 x 400 W HPSV (T)/MHL (T)	₹ 4400

Note: Please order suitable control gear box from page no. 77

WFZ 32
WFZ 32

IP 65 heavy duty non-integral single lamp symmetric beam floodlight

new

WFZ 32250	1 x 250 W HPSV (E/T)/MHL (T)	₹ 6100
WFZ 32400	1 x 400 W HPSV (E/T)/MHL (T)	₹ 6100

Note: Please order control gear box from page no. 77

Lumino
WFZ 68

Non-integral symmetric wide beam floodlight

WFZ 68250	2 x 250 W HPSV (T)/MHL (T)	₹ 6850
WFZ 68400	2 x 400 W HPSV (T)/MHL (T)	₹ 6850

Note: Please order control gear box from page no.77

street & flood

High Mast & Poles



High Mast Lighting

High Mast lighting is currently the most efficient and cost effective way of illuminating large outdoor areas such as highways, railway yards, dock yards, parking lots, shopping centers, power plants, coal mines, warehouses, toll plazas and road junctions.

High Masts can be mounted at considerable heights, thus rendering uniform illumination to the entire area. It also enables easier installation and maintenance of luminaires due to motorized controls that lowers and raises the luminaires. The sleek High Masts lighting is also aesthetically superior to the conventional lattice structures or lower height poles.

Wipro Lighting offers comprehensive range of solutions in high masts. The range is available in standard heights, 12/16/20/25/30 metres. All these options support various luminaire combinations depending on lighting design requirements.



Poles

Poles are the backbone of efficient street lighting applications and urban city beautification projects. Town planners and urban developers today require poles which blend with modern city landscapes and provide a distinguished look to the area.

Wipro Lighting offers a wide range of products right from 5 metre to 12 metre poles with different bracket options (poles beyond 12 metres can also be provided on request). The solutions may vary for GI Octagonal Poles, Tubular Poles or Conical Decorative poles. We offer a wide variety of bracket options to suite the aesthetics of the landscape and the luminaires used.

The design and specification of the poles and the luminaires depend on the type of application.



high masts & poles

Wipro Lighting has a dedicated team of Lighting Design Engineers located across India to recommend a comprehensive solution as per customer requirements. For more Techno - Commercial details on Poles and High Mast Lighting, contact our nearest Branch or write to helpdesk.lighting@wipro.com.

Landscape



outdoors
come alive



Good lighting for
outdoors is all about
beautifully lit up pathways,
shimmering wall lights
& sparkling underwaters
that exhilarates
the landscapes



Winner of prestigious India Design Mark & European Design Award

floodlight

A MICHEL TORTEL DESIGN

O' the circular floodlight is the true representation of logical, intuitive imagination blended with perfection to the realistic, functional needs of a floodlight

landscapes

smart visors
to cut down glare

O Flood

WFH 20

Integral floodlight luminaire with circular reflector

WFH 20070N	1 x 70 W MHL (HIT-DE)	₹ 27000
WFH 20070W	1 x 70 W MHL (HIT-DE)	₹ 27000
WFH 20150N	1 x 150 W MHL (HIT-DE)	₹ 29800
WFH 20150W	1 x 150 W MHL (HIT-DE)	₹ 29800

Landscape

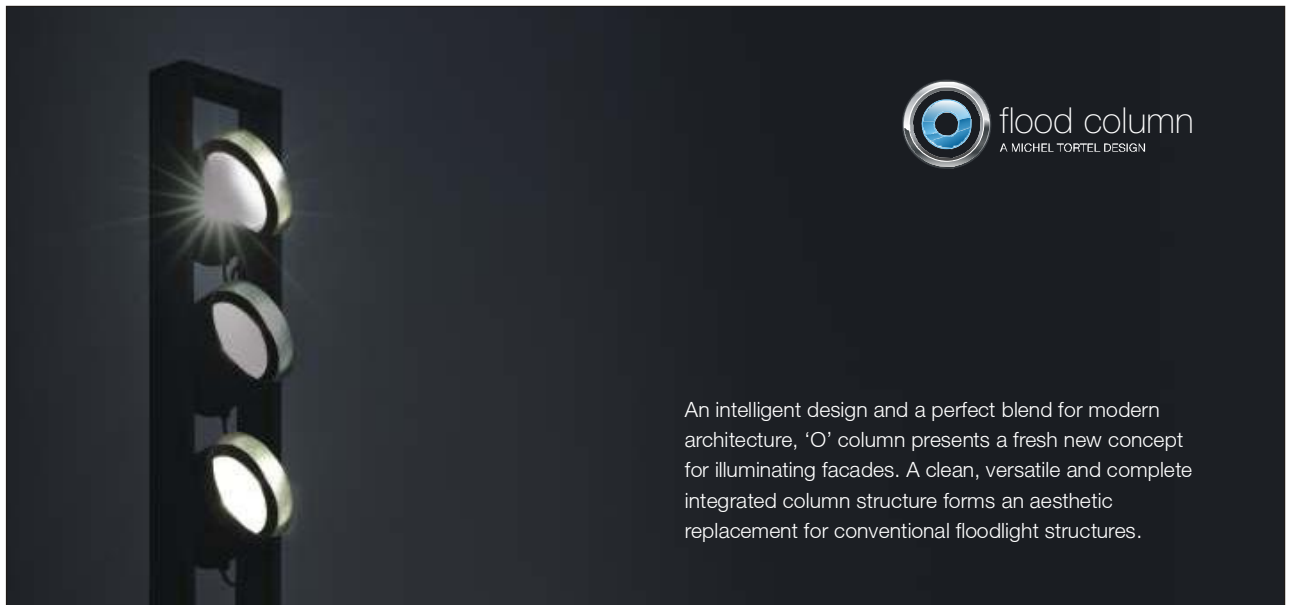

An intelligent design and a perfect blend for modern architecture, 'O' column presents a fresh new concept for illuminating facades. A clean, versatile and complete integrated column structure forms an aesthetic replacement for conventional floodlight structures.



O Flood Column

WFH 20

Integral floodlight column



Winner of prestigious India Design Mark & European Design Award

WFZ 23070ZZN	1 x 70 W MHL (HIT-DE)	On request
WFZ 23070ZZW	1 x 70 W MHL (HIT-DE)	On request
WFZ 23150ZZN	1 x 150 W MHL (HIT-DE)	On request
WFZ 23150ZZW	1 x 150 W MHL (HIT-DE)	On request
WFZ 24070ZZN	1 x 70 W MHL (HIT-DE)	On request
WFZ 24070ZZW	1 x 70 W MHL (HIT-DE)	On request
WFZ 24150ZZN	1 x 150 W MHL (HIT-DE)	On request
WFZ 24150ZZW	1 x 150 W MHL (HIT-DE)	On request

Fantasy Bollard

FBP 32

Die cast aluminium bollard with UV stabilized polycarbonate diffuser, suitable for CFL (TC-D) lamps



FBP 32118	1 x 18 W CFL (TC-D)	₹ 6500
FBP 32126	1 x 26 W CFL (TC-D)	₹ 6800

Fantasy Wall Light

FWP 41

Wall or ceiling light in reinforced thermoplastic housing & vandal resistant polycarbonate diffuser, suitable for CFL (TC-D) lamps



FWP 41218	2 x 18 W CFL (TC-D)	₹ 6600
-----------	---------------------	--------

Fantasy Wall Light

FWP 42

Wall light in reinforced thermoplastic housing and vandal resistant polycarbonate diffuser, suitable for CFL (TC-D) lamps



FWP 42118	1 x 18 W CFL (TC-D)	circular	₹ 2500
FWP 42126	1 x 26 W CFL (TC-D)	circular	₹ 2800

Fantasy Wall Light

FWP 47

Wall light in reinforced thermoplastic housing and vandal resistant polycarbonate diffuser, suitable for CFL (TC-D) lamps



FWP 47118	1 x 18 W CFL (TC-D)	square	₹ 2500
FWP 47126	1 x 26 W CFL (TC-D)	square	₹ 2800

Urbano Pathway

UPH 11

Decorative pathway luminaire in die cast aluminium housing and clear PMMA diffuser, suitable for HIE (MHL) lamps



UPH 11070B*	1 x 70 W HIE	₹ 65300
UPH 11070S*	1 x 70 W HIE	₹ 66500

* Prices are without pole
* Suffix B stands for black color and Suffix S stands for silver color

Urbano Pathway

UPH 21

Decorative pathway luminaire with symmetrical indirect light distribution, suitable for HIT-CE lamps



UPH 21070B*	1 x 70 W HIT-CE	₹ 65300
UPH 21070S*	1 x 70 W HIT-CE	₹ 66500
UPH 21150B*	1 x 150 W HIT-CE	₹ 67500
UPH 21150S*	1 x 150 W HIT-CE	₹ 68700

* Prices are without pole
* Suffix B stands for black color and Suffix S stands for silver color

landscapes

Landscape

Fantasy Pathway

FPH 68

Die cast aluminium pathway light suitable for MHL (HIT-DE) lamps



FPH 68070*	1 x 70 W MHL HIT-DE (double ended)	₹ 30200
FPH 68150*	1 x 150 W MHL HIT-DE (double ended)	₹ 30700

* Prices are without pole

Fantasy Pathway

FPP 21

Post top luminaire with diffused acrylic globe, suitable for CFL (TC-EL) lamps



FPP 21115	1 x 15 W CFL (TC-EL)	₹ 1850
FPP 21123	1 x 23 W CFL (TC-EL)	₹ 1850

Fantasy Pathway

FPS 31

Post top luminaire with clear acrylic globe and refractor suitable for HPSV lamps



FPS 31070	1 x 70 W HPSV (E)	₹ 16800
-----------	-------------------	---------

Fantasy Driveover

FDQ 45

Decorative driveover with housing in die cast aluminium, clear toughened glass, suitable for PAR 20 mains voltage halogen lamps



FDQ 45050	1 x 50 W Halogen PAR-20	Lamp base E27	₹ 7100
-----------	-------------------------	---------------	--------



Fantasy Driveover

FDQ 46

Decorative driveover with housing in die cast aluminium, stainless steel ring suitable for PAR 20 mains voltage halogen lamps



FDQ 46050	1 x 50 W Halogen PAR-20	Lamp base G12	₹ 10100
-----------	-------------------------	---------------	---------



landscapes

Fantasy Floodlight FFQ 51



Symmetrical bush light with housing in die cast aluminium with clear toughened glass suitable for PAR 20 lamps

FFQ 51050	1 x 50 W Halogen PAR 20	Lamp base E27	₹ 3300
FFX 511	Directional Shield		₹ 750
FFX 512	Earth Spike		₹ 800

Fantasy Steplight FSP 42



Wall recessed step light with light direction frame in fibre reinforced plastic, suitable for CFL (TC-D) lamps

FSP 42118	1 x 18 W CFL (TC-D)	₹ 5500
FSP 42126	1 x 26 W CFL (TC-D)	₹ 5700

Fantasy Underwater FUQ 11



Surface mounted heavy duty underwater luminaire for fountain lighting and suitable for halogen lamps

FUQ 11050*	1 x 12V/50 W	₹ 14100
Recess mounted transformer housing along with transformer		
FUQ 21050	Control gear box suitable for 50 W Dichroic halogen lamp	₹ 10150

*Please order FUQ 21050 separately

Fantasy Underwater FUQ 12



Recess mounted heavy duty underwater luminaire for swimming pool lighting and suitable for halogen lamps

FUQ 12050*	1 x 12V/50 W	₹ 23150
Recess mounted transformer housing along with transformer		
FUQ 21050	Control gear box suitable for 50 W Dichroic halogen lamp	₹ 10150

*Please order FUQ 21050 separately

Accessories



WGM/S/H 16/56

WGM/S/H 16/56

Control gear boxes for HPMV lamps



		16 series	56 series
WGM 16/56080	1 x 80 W HPMV	₹ 2850	₹ 3300
WGM 16/56125	1 x 125 W HPMV	₹ 2950	₹ 3400
WGM 16/56250	1 x 250 W HPMV	₹ 3900	₹ 4400
WGM 16/56400	1 x 400 W HPMV	₹ 4400	₹ 4950
Control gear boxes for HPSV lamps			
WGS 16/56070	1 x 70 W HPSV (E) (with internal starter)	₹ 3200	₹ 3400
WGS 16/56071	1 x 70 W HPSV (E) (without internal starter)	₹ 3500	₹ 3650
WGS 16/56150	1 x 150 W HPSV	₹ 3950	₹ 4450
WGS 16/56250	1 x 250 W HPSV	₹ 5000	₹ 5400
WGS 16/56400	1 x 400 W HPSV	₹ 5750	₹ 6300
Control gear boxes for Metal Halide lamps			
WGH 16/56070	1 x 70 W MHL	₹ 3200	₹ 3400
WGH 16/56150	1 x 150 W MHL	₹ 3950	₹ 4450
WGH 16/56250	1 x 250 W MHL	₹ 5000	₹ 5400
WGH 16/56400	1 x 400 W MHL	₹ 5750	₹ 6300
eg: For 150 W control gear box - WGH 16/56150 following are the subcodes HGH 56150 (housing) and WBS/H 56150 SL31 (ballast)			

WBS/H 56/57

WBS/H 56/57

Open construction ballast for HPSV/MHL lamps



WBS/H 56070 SL31	1 x 70 W HPSV/MHL	₹ 1250
WBS/H 57070 SL31*	1 x 70 W HPSV/MHL	₹ 1250
WBS/H 56150 SL31	1 x 150 W HPSV/MHL	₹ 2100
WBS/H 57150 SL31*	1 x 150 W HPSV/MHL	₹ 2100
WBS/H 56250 SL31	1 x 250 W HPSV/MHL	₹ 2800
WBS/H 56400	1 x 400 W HPSV/MHL	₹ 3900
* WBS/H 57070 series of ballast is suitable for WW562 series of wellglass		
* WBS/H 57150 series of ballast is suitable for WW560 series of wellglass		

WGS/H 59

WGS/H 59

Control gear boxes for HPSV and MHL lamps



WGS/H 59250	2 x 250 W HPSV(T)/MHL(T)	₹ 9600
WGS/H 59400	2 x 400 W HPSV(T)/MHL(T)	₹ 12900
eg: For 250 W control gear box - WGS/H 59250 following are the subcodes HGS/H 59250 (housing) and WBS/H 56250 SL31 (ballast)		



accessories

Starter/Ignitor

WEH 24/29/35/45

Starter and Ignitor

WEH 24001	Ignitor for 70/150/250/400W HPSV/MHL for 5 mts. striking distance	₹ 325
WEH 29001	Ignitor for 70/150/250/400W HPSV/MHL for 30 mts. striking distance	₹ 500
WEH 35001	Super imposed pulse ignitor for 35/70/150/250/400W MHL	₹ 600
WEH 45001	Super imposed pulse ignitor (stud mounted) for 35/70/150 W MHL	₹ 700

WBM 15/WBS 20/WBH 26

WBM 15/WBS 20/WBH 26

Ballasts for HPMV lamps

WBM 15080/16080	1 x 80 W HPMV	₹ 1200
WBM 15125/16125	1 x 125 W HPMV	₹ 1250
WBM 15250	1 x 250 W HPMV	₹ 2250
WBM 15400	1 x 400 W HPMV	₹ 2800

Ballast for HPSV lamps

WBS 20070/23070*	1 x 70 W HPSV	₹ 1200
WBS 20150/24150*	1 x 150 W HPSV	₹ 2000
WBS 20250	1 x 250 W HPSV	₹ 2750
WBS 22400	1 x 400 W HPSV	₹ 4000

*WBS 23070 is suitable for WWS 62 series and WBS 24150 is suitable for WWS 60 series

Ballasts for Metal Halide lamps

Lamp Wattage	Suitable for 3 wire ignitor	Suitable for super imposed pulse ignitor	Price (₹)
35 W	–	WBH 15035	₹ 1300
70 W	WBH 26070/28070*	WBH 25070	₹ 1300
150 W	WBH 26150/24150*	WBH 25150	₹ 2000
250 W	WBH 26250	WBH 25250	₹ 2800
400 W	WBH 28400	WBH 27400	₹ 4100

*WBS 28070 is suitable for WWH 62 series of luminaires and WBH 24150 is suitable for WWH 60 series of wellglass

Discontinued Products

Series	Cat. No.	Price
LED		
Pure LED	LM14-008-XXX-WH-XX	₹ 8950
	LM14-032-XXX-WH-XX	₹ 15300
Disk LED	LD49-900-XXX-WH-XX	₹ 6100
	LD49-161-XXX-WH-XX	₹ 7600
Play LED	LD38-006-XXX-WH-XX	₹ 4150
	LD46-006-XXX-WH-XX	₹ 5000
	LD41-018-XXX-WH-XX	₹ 13250
	LD36-018-XXX-WH-XX	₹ 12350
	LD30-006-XXX-WH-XX	₹ 6250
	LD31-012-XXX-WH-XX	₹ 8600
	LD32-018-XXX-WH-XX	₹ 12250
	LD37-018-XXX-WH-XX	₹ 12400
	LD39-024-XXX-WH-XX	₹ 15550
	LD45-006-XXX-WH-XX	₹ 7000
	LD43-012-XXX-WH-XX	₹ 8750
	LD40-018-XXX-WH-XX	₹ 11800
Kolors Striplight	LD47-024-XXX-WH-XX	₹ 27900
	LS10-003-XXX-WH-05	₹ 9700
	LS10-003-XXX-WW-05	₹ 9700
	LS10-003-XXX-CC-05	₹ 13300
	LS10-005-XXX-WH-10	₹ 18500
	LS10-005-XXX-WW-10	₹ 18500
Kolors Striplight Driver	LS10-005-XXX-CC-10	₹ 25200
	LG24-020 DC	₹ 6300
Kolors Downlighter	LD20-003-045-RD-XX	₹ 7200
	LD20-003-045-GR-XX	₹ 7200
	LD20-003-045-BL-XX	₹ 7200
	LD20-003-045-AM-XX	₹ 7600
	LD20-003-045-WH-XX	₹ 7200
	LD20-003-045-WW-XX	₹ 7200
LED Driver	LG40-006	₹ 1700
Kolors Floodlight	LF32-036-015-CC-XX	₹ 87900
	LF41-009-016-WH-03	₹ 32200
	LF41-009-016-CC-03	₹ 33400
	LF41-015-016-WH-05	₹ 49200
	LF41-015-016-CC-05	₹ 51200
	LF41-021-015-WH-06	₹ 57500
	LF41-021-015-CC-06	₹ 58900
Modern Workspaces		
Spacio	WVP 52236 SGA	₹ 5850
	WVP 52140 SGA	₹ 5850
	WVF 53414 SGA	₹ 6550
Ideos	WVP 78236 SGA	₹ 5600
	WVF 78414 SGA	₹ 6950
	WVP 79236 SGA	₹ 5700
	WVF 79414 SGA	₹ 7000
Platinum	WVP 74236	₹ 5000
	WVP 74236 SG	₹ 5100
	WVP 74236 SGW	₹ 5550
	WVP 74236 SGA	₹ 5950
	WVP 74240 SGA	₹ 6150
	WVP 74255 SGA	₹ 6350
	WVF 74414 SGW	₹ 6500
	WVF 74414 SGA	₹ 7250
Platina	WVP 76236 SGA	₹ 4500
	WVF 76414 SGA	₹ 5950
Softlite	WCP 63236 SGA	₹ 4450
Fusion	WCP 64236 SGA	₹ 4750

Series	Cat. No.	Price
Pristine	WVP 56236 SGA	₹ 4650
Etern	WVP 57236 SGA	₹ 5000
	WVF 82236 SGA	₹ 7250
Float	WVF 82228 SGA	₹ 7350
	WVF 82436 SGA	₹ 15400
	WVF 82428 SGA	₹ 15500
	WVF 83228 SGA	₹ 7600
Aeros-DP	WVF 83428 SGA	₹ 16400
	WVF 84228 SGA	₹ 8950
Aeros-MPL	WVF 84428 SGA	₹ 17900
NT5	WVF 22228 SGA	₹ 5950
	WVP 20336 SGW	₹ 6000
Stellar	WVF 20314 SGA	₹ 6300
	WVF 20414 SGA	₹ 6700
	WVP 24236 SGA	₹ 5700
Crescent	WVP 24236 SGA	₹ 5700
	WCP 97336	₹ 4600
Matrix	WCP 97336 SGW	₹ 5550
	WCF 74236	₹ 4700
WCF 74	WCF 74236 SGW	₹ 5200
	WCF 82136	₹ 2200
WCF 82	WCF 82136 SGW	₹ 2700
	WCF 82236	₹ 3250
	WCF8 2236 SG	₹ 3350
	WCF 82236 SGW	₹ 3750
WVP 41	WVP 41236	₹ 2950
	WVP 41236 SG	₹ 3050
	WVP 41236 SGW	₹ 3400
Lighting Controls		
eSense	COP 12010	₹ 12400
	CDD 14020	₹ 14950
	CDD 22020	₹ 27000
	CDD 25020	₹ 22300
	CLD 15020	₹ 13450
	COP 16006	₹ 8400
	CTX 17010	₹ 5850
	CTX 18010	₹ 6400
	CSC 0404 + CDX 0404	₹ 103400
	CSC 0204 + CDX 0204	₹ 103400
CSC 0600 + CDX 0600	₹ 126900	
Commercial Interiors		
Cubix 10	GCP 10113/118	₹ 1700
	GCP 10213/218	₹ 1900
	GCP 10118 SG	₹ 1850
	GCP 10118 SGW	₹ 2300
	GCP 10218 SG	₹ 2250
	GCP 10218 SGW	₹ 2500
Eyeball	WCQ 22150	₹ 450
Rhythm	GRP 90142 SGA	₹ 8500
Industries		
Indixt	WHF 31428 SGA	₹ 9300
	WHF 32428 SGA	₹ 9300
	WHF 33428 SGA	₹ 10900
	WHF 34428 SGA	₹ 10900
Indibay	WHP 30436 SGW	₹ 6150
	WHP 30436 SGA	₹ 7450
	WHP 30440 SGA	₹ 7850
	WHP 30455 SGA	₹ 8350
	WHF 30628 SGW	₹ 10300
	WHF 30628 SGA	₹ 12600

Wipro Lighting Price List 2013

Series	Cat. No.	Price
Indibay	WHF 30654 SGA	₹ 13500
Saviour	WIF 20136 SG	₹ 1100
Streetlights		
WSF 15	WSF 15140	₹ 2750
	WSF 15240	₹ 3400
WSP 11	WSP 11136	₹ 2200
Magnus	WHP 18136	₹ 5850
	WHP 18136 SGW	₹ 6350
Floodlights		
Area	WFH 56070	₹ 4650
	WFH 57070	₹ 4800
	WFH 58070	₹ 4500
Vector	WFH 51070	₹ 6000
	WFH 51150	₹ 6200
	WFT 52150	₹ 7500
	WFT 52250	₹ 8500
	WFT 52400	₹ 9000
	WFH 52250	₹ 8500
	WFH 52400	₹ 9000
WFZ 31	WFZ 31250	₹ 6200
	WFZ 31400	₹ 6200

Series	Cat. No.	Price
Landscapes		
Fantasy Bollard	FBP 31118	₹ 33000
	FBP 31126	₹ 19600
Fantasy Wall Light	FWP 22118	₹ 10250
	UPH 31070B	₹ 52500
Urbano Pathway	UPH 31070S	₹ 53600
	UPH 31150B	₹ 54650
	UPH 31150S	₹ 55750
Fantasy Driveover	FDH 31070	₹ 76300
Urbano Floodlight	UFH 11070B	₹ 26000
	UFH 11070S	₹ 27200
	UFH 11150B	₹ 31100
	UFH 11150S	₹ 32200
Urbano Steplight	USP 11126B	₹ 20150
	USP 11126S	₹ 21200
	USH 11070B	₹ 25250
Urbano Underwater	USH 11070S	₹ 26350
	UUQ 11050	₹ 32250
	UUQ 21050	₹ 25500

Technical details

- All luminaire prices are without lamps except for LED range.
- The list prices are inclusive of excise duty at the prevailing rates. In case of any increase in the same it shall be to the customer's account.
- Local levies and taxes, as applicable, will be extra on these list prices.
- Please contact authorised Wipro sales person/stockists for prices marked as 'On request'.
- Prices are subject to change without notice as per company discretion.
- All prices are subject to our general terms and conditions of business.
- Authorised sales person and stockists can sell below the list price.
- Items other than those included in the price list, stands withdrawn from the range.
- This price list supersedes all earlier price lists.
- MRP wherever mentioned are inclusive of excise duty and sales tax as per the prevailing rates

Terms and Conditions

- All FTL/CFL luminaires are with slim open type copper ballast (unless otherwise specified).
- The suffix SG in the Cat Nos. stands for Sigma Electronic Ballast.
- The suffix SGW in the Cat nos. stands for Sigma Warm-start Electronic Ballast.
- The suffix SGA in the Cat nos. stands for Sigma Active Power Factor Correction Ballasts.
- HPSV luminaires suitable for 70W HPSV (I) lamp with internal starter are not wired with external ignitor. All other integral luminaires are wired with external ignitor (Cat no. WEH 24001) for HPSV lamps and Metal Halide lamps. These ignitors are suitable for striking within 5 mts distance.
- External ignitor for striking upto 30 mts distance is WEH 29001 for HPSV and Metal Halide lamps.
- Suitable control gear box for all non-integral products need to be ordered separately.

Innovation and improvement are a way of life at Wipro. All rights reserved.
 Reproduction of this data in part or in whole without permission is prohibited.
 Care has been taken to ensure that the information content within is correct.
 We reserve the right to modify the product without prior intimation. Photographs shown herein are indicative.

Wipro Furniture

Innovation and Design is a way of life at Wipro Furniture

Wipro Furniture Business is a part of Wipro Enterprises Limited with operations, sales offices and dealers in over 27 locations across India, serving customers virtually anywhere in India. Our business office and design center is based out of Bangalore. Our manufacturing facilities are located in Waluj (Aurangabad) and Guduvanchery (Chennai). Since the start of furniture business, the company has created and nurtured over 30 successful sub brands.

Wipro Furniture offers complete range of office furniture solutions which includes workstations, benching, cabin furniture, full height partition systems, conference/meeting tables, discussion tables, educational furniture, task seating, executive seating, board room seating, multipurpose seating and breakout zone tables & chairs.

At Wipro Furniture we believe that as business grows and work styles change, workspaces too evolve. We research evolving work environments then design, deliver products and services that make these environments work better. Our furniture is designed for people and the way they work today.

Wipro Furniture Business has been in the fore front of conceptualizing, designing and offering products in creating Open Office Architecture spaces in Indian scenario. Wipro are the leaders in providing "Open Office Architecture based solutions. Our association with international designers like Tim Wallace, Eric Chan, Conrad Marini and others is a conscious effort to bring in International design and research benefits to Indian customers.

Innovation and Design is a way of life at Wipro Furniture. Our focus has always been to create futuristic, vibrant and sustainable products for modern workspace. Layers of bureaucratic process and hierarchy are giving way to new work styles. Now, new generations of employees are bringing a spirit of sharing and collaboration to the workplace. As people move seamlessly between home-office, on-site work teams, and outdoor cafe meetings, modular furniture can significantly increase the flexibility of today's workspace. Our products can help your organisation in bringing change, building attitude and booming productivity.

innovation | design®
workstation seating conference benching



startline
a Tim Wallace Design



India's first leg and beam based system



Vibrant™ plus



WIPRO SEATING

For more information write to us at vibrant.solutions@wipro.com

website: www.wiprofurniturebusiness.com

NORTH-WEST

STYLE & RELIABILITY



we understand switches,
we understand you

Switches, the silent performers of every home, barely catch attention, anytime. With multiple clicks every hour, everyday, year after year, these devices perform efficiently and safeguard our assets. A simplest of a switch is packed with features that represent the values and promise of the brand. North-West one of the pioneers in the modular switch industry and having over two decades of experience in designing and manufacturing switches; is recognized for its high reliability and innovative edge in modular switches.

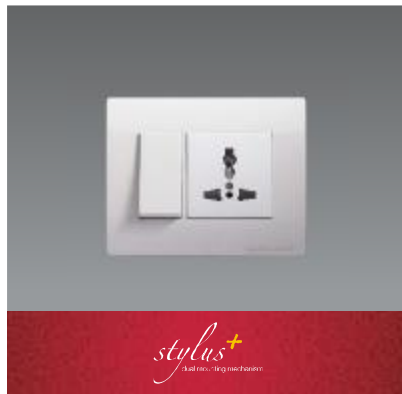

Branch Offices

E-40/7, Okhla Industrial Area, Phase-II,
New Delhi – 110 020
Tel: 011-41708121 / 29
email: ratnesh.pande@wipro.com

No.139, 7th Cross, N S Palya, Off. Bannerghatta Road,
Bangalore - 560 076
Tel : 080-41503260 / 41503268
email: mathew.george1@wipro.com

3, Pretoria Street, 3rd Floor,
Kolkata - 700 071
Tel: 033-44045886 / 44045887
email: amartya.gupta@wipro.com

Plot No., 13 A /1, Road No. 9, IDA East Division Nacharam, R.R.Distt.,
Hyderabad - 500 076
Tel: 040 -27176082 / 27178906 / 27178905
email: abhiroop.upadhyay@wipro.com

203 / 204, Hindustan Kohinoor Complex,
Next To HCC, LBS Marg, Vikhroli - West
Mumbai - 400 083
Tel: 022-67213755, Fax: 022-67213771
email: amar.paralikal@wipro.com, pushkar.darade@wipro.com

Door No 33 & 34 - P V G Complex
G.K. Industrial Estate, Ganesh Nagar, Alapakkam,
Chennai - 600 116
Tel: 044-32518016 / 24769653
email: karunakaran.muthu@wipro.com, dipankar.dutta@wipro.com

Bhosale Heights, 1195/5, Fergusson College Road,
Pune - 411 005
Tel: 020-25510583 / 25535081
email: nitin.sune@wipro.com, gopalakrishnan.sriram@wipro.com

S .C .O. - 208 - 209, 3rd Floor Sector - 34A,
Chandigarh - 160 022
Tel: 0172-5018734 / 2660714 / 92161 08102 / 98143 50562
email: rajeev.bharadwaj@wipro.com, rajiv.sharma3@wipro.com

Karnal
Mobile: 96719 60518 / 98143 50562
email: atul.mukhija@wipro.com, rajiv.sharma3@wipro.com

E/149, Transport Nagar, Lucknow Kanpur Road,
Lucknow - 226 012
Tel: 0522-2434352 / 94250 72138
email: achiranshu.mishra@wipro.com, akhilesh.chouhan@wipro.com

Lokra Chariali N.H. 37
Guwahati - 781037
Mobile: 98310 69725 / 98310 69725
email: pronab.sinha@wipro.com, amartya.gupta@wipro.com

Jodhpur
Mobile : 99282 11211
email : sumit.sharma23@wipro.com, ashish.agrawal4@wipro.com

Ludhiana
Mobile: 92165 94049 / 98143 50562
email: yatinder.rana1@wipro.com, rajiv.sharma3@wipro.com

Dehradun
Mobile: 98143 50562
email: rajiv.sharma3@wipro.com

Mauji 434, Khata No. 40, Ground Floor Bari Pahari transport Nagar,
PS Agamkaun
Patna - 800007
Mobile: 97714 14655 / 98310 69725
email: mani.bhushan1@wipro.com, amartya.gupta@wipro.com

B - 16 / 17, Palsania Complex, Near T B Hospital,
Subhash Nagar Shopping Centre,
Jaipur - 320 016
Tel: 0141- 2280289 / 077-42725365
email: joy.bhattacharya@wipro.com, ashish.agrawal4@wipro.com

H-409, Titanium City Centre, besides Sachin Tower, 100 Ft. Road,
Anand Nagar
Ahmedabad – 380015
Tel: 079-40073546 / 98980 01521
email: ashish.agrawal4@wipro.com

Surat
Mobile : 99254 40019
email : sanjay.verma7@wipro.com, ashish.agrawal4@wipro.com

Khasra No.1470/81, P H No.106, Ring Road No.1,
Near Jagdamba Mandir, Opp Hotel New Relax, Kushalpur,
Raipur - 492001
Tel: 0771 – 3265725 / 98812 47167
email: kumar.abhinav1@wipro.com, prasad.shiledar@wipro.com

Bhopal
Mobile: 88782 44344 / 94250 72138
email: pushpendra.singh1@wipro.com, akhilesh.chouhan@wipro.com

Jamshedpur
Mobile: 85214 48424 / 98310 69725
email: cedric.peter@wipro.com, amartya.gupta@wipro.com

1-99, Sirigudi Nagar, Yendada
Vishakhapatnam - 530 045
Tel: 96184 56143 / 96528 21212
email: ramakrishna.prasad@wipro.com, abhiroop.upadhyay@wipro.com

Aurangabad
Mobile : 98222 44448
Email: vivek.shukla4@wipro.com, sachin.gupta7@wipro.com

Kalburgi Building, Opp: NWKSRTC Bus Stand, Gokul Road
Hubli - 580030
Mobile : 95382 96651 / 95619 62002
Email: bapugouda.patil@wipro.com, parikshit.kinari@wipro.com

Mangalore
Mobile: 97405 22899 / 99614 64188
email: basavaraja.s38@wipro.com, pradeep.r80@wipro.com

No.41, Chokkampudur Main Road, Sriram Nagar, Telungupalayam Post,
Coimbatore - 641 039
Mobile: 96556 93535 / 98439 48439
email: sundar.s35@wipro.com, lakshmigantan.m47@wipro.com

311, Pujer Complex, Subhanpura,
Baroda - 390 023
Tel: 0265-2395830 / 35 / 36 / 41 / 45 / 90999 24867 / 98980 01521
email: ambuj.singh2@wipro.com, ashish.agrawal4@wipro.com

Rajkot
Mobile : 99980 57866
email : ravi.srivastava1@wipro.com, ashish.agrawal4@wipro.com

86/8/1, Lasudia Mori, Dewas Naka, near Shivani Transport,
Indore - 457 371
Tel: 0731-3299668 / 94250 72138 / 96173 63605
email: akhilesh.chouhan@wipro.com

Jabalpur
Mobile : 98222 44448
Email: anil.choudhary2@wipro.com, sachin.gupta7@wipro.com

Hindustan Associates, Plot no. 135,
Mancheshwar Industrial Estate, Rasulgarh,
Bhubaneswar - 751 010
Mobile: 99030 27514 / 98310 69725
email: chitrak.sardar@wipro.com, amartya.gupta@wipro.com

Flat No. 8, Plot No. 191, 1st Floor, Rachna Apartment, Cement Road,
Shivaji Nagar,
Nagpur - 440 010
Tel: 0712 – 2569878 / 98812 47167
email: prasad.shiledar@wipro.com

Advani Business Centre, Nilkamal Arcade,
Near Hotel Rajdhani, Atmaram Borkar Road, Panjim,
Goa - 403001
Mobile: 95619 62002
email: parikshit.kinari@wipro.com

VI/409-D, Valomkottil Building
Opp. BMC, Sea Port-Air Port Road, P.O. Thrikkakkara,
Cochin – 682 021
Mobile: 98950 65656 / 99614 64188
email: e17.mohan@wipro.com, pradeep.r80@wipro.com

Madurai (Tamilnadu)
Mobile : 84891 45683 / 98439 48439
Email: vijay.a97@wipro.com, lakshmigantan.m47@wipro.com,

Wipro Lighting Advantage

Innovative lighting solutions for indoor and outdoor applications through:

- Energy saving solutions with latest international technologies
- Capability to service multi-locational accounts
- Service commitment : 35 branches and over 350 dedicated stockists
- Ease of contact through website
- Trustworthiness and Reliability of Wipro

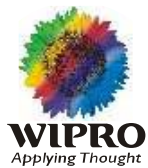

Business Office:
Wipro Lighting, 5th floor, Godrej Eternia - C, old Pune-Mumbai road,
Shivajinagar, Pune - 411 005
Tel : 020-66098700, Fax : 020-66098777, E-mail : helpdesk.lighting@wipro.com

Registered Office:
Wipro Enterprises Ltd.
#134, Doddakannelli, Sarjapur road, next to Wipro corporate office, Bangalore - 560035
Tel : 080-28440011, Fax : 080-28440057

www.wiprolighting.com

AUTHORISED STOCKIST: